

---

Z 8 8

---

*User Manual*

---



CAMBRIDGE  

---

COMPUTER



---

# Z88 USER GUIDE



This manual was written, designed and laser-typeset by  
Human-Computer Interface Limited, Cambridge, U.K.

Copyright © Cambridge Computer Limited 1987, 1988

First published in 1987 by  
Cambridge Computer Limited, Cambridge, U.K.

All rights reserved.

No part of this book may be reproduced by any means without the prior consent of the copyright holder. The only exceptions are as provided for by the Copyright (photocopying) Act or for the purpose of review or in order for the software herein to be entered into a computer for the sole use of the owner of this book.

Cambridge Computer Limited will not in any event be liable for any loss, including consequential loss, caused by any error, defect, or failure of the computer however arising, including but not limited to loss of use, loss of stored data, loss of profit, or loss of contracts.

### THIRD EDITION

The Z88 system software was designed and developed by Protechnic Limited, Cambridge, U.K.

PipeDream was designed and developed by Colton Software Limited, Cambridge, U.K.

The Z88 Operating System was designed and developed by Operating Systems Limited, Cambridge, U.K.

The companies involved in the development of the Z88 software have been incorporated as Trinity Concepts Limited, Cambridge, U.K.

BBC BASIC (Z80) is copyright R. T. Russell, supplied under licence by M-Tec Computer Services (UK). A comprehensive manual for BBC BASIC can be obtained from: M-TEC Computer Services, 4 Church Hill, Reepham, Norfolk, NR10 4JL, U.K. Telephone 0603 870620.

## **FCC COMPLIANCE STATEMENT**

**WARNING:** This equipment has been certified to comply with the limits for a Class B computing device, pursuant to Subpart J of Part 15 of FCC Rules. Only peripherals (computer input/output devices, terminals, printers, etc.) certified to comply with the Class B limits may be attached to this computer. Operation with non-certified peripherals is likely to result in interference to radio and TV reception.

This equipment generates and uses radio frequency energy and if not installed and used properly, that is, in strict accordance with the manufacturer's instructions, may cause interference to radio and television reception. It has been type tested and found to comply with the limits for a Class B computing device in accordance with the specifications in Subpart J of Part 15 of FCC Rules, which are designed to provide reasonable protection against such interference in a residential installation. However, there is no guarantee that interference will not occur in a particular installation. If this equipment does cause interference to radio or television reception, which can be determined by turning the equipment off and on, the user is encouraged to try to correct the interference by one or more of the following measures:

- Reorient the receiving antenna
- Relocate the computer with respect to the receiver
- Move the computer away from the receiver
- Plug the computer into a different outlet so that the computer and receiver are on different branch circuits.

If necessary, the user should consult the dealer or an experienced radio/television technician for additional suggestions. The user may find the following booklet prepared by the Federal Communications Commission helpful:

“How to Identify and Resolve Radio-TV Interference Problems”.

This booklet is available from the U.S. Government Printing Office, Washington, DC 20402, Stock No. 004-000-00345-4.

## **WARNING**

The connection of a non-shielded printer interface cable to this computer will invalidate the FCC certification of this device and may cause interference which exceeds the limits established by the FCC for this equipment.

---

# CONTENTS

INTRODUCTION	<b>Section One – Getting started</b>	<b>3</b>
	Introducing the Z88	4
	Up and running	6
	The Z88 applications and popdowns	11
	Basic concepts	15
TUTORIAL	<b>Section Two – Using PipeDream</b>	<b>31</b>
	Starting PipeDream	32
	Designing a party invitation	37
	Compiling a name and address list	46
	Calculating home expenses	56
	<b>Section Three – Using the Diary</b>	<b>65</b>
	<b>Section Four – Using the popdowns</b>	<b>69</b>
	The Calculator – □R	70
	The Calendar – □C	75
	The Clock – □T	77
	The Alarm – □A	78
	The Filer – □F	80
	The Panel – □S	87
	Import/Export – □X	90
	The Index – <span style="border: 1px solid black; padding: 0 2px;">INDEX</span>	92
REFERENCE	<b>Section Five – PipeDream reference</b>	<b>103</b>
	Operations on blocks of slots – BLOCKS	104
	Moving about the document – CURSOR	114
	Editing text and expressions – EDIT	118
	Working with files – FILES	125
	Altering the document layout – LAYOUT	131
	Document options – OPTIONS	138
	Printing documents – PRINT	146
	Expression slots	150

	<b>Section Six – The Diary reference</b>	<b>161</b>
	Operations on a block of text – BLOCKS	162
	Moving around the Diary – CURSOR	166
	Editing the Diary – EDIT	170
	Loading and saving – FILES	172
	<b>Section Seven – Filer reference</b>	<b>175</b>
	<b>Section Eight – The Terminal</b>	<b>185</b>
	<b>Section Nine – The Printer Editor</b>	<b>187</b>
	<b>Section Ten – BBC BASIC</b>	<b>195</b>
	BASIC keywords	199
	BASIC operators	223
<b>APPENDICES</b>		
	<b>Appendix A – Replacing batteries</b>	<b>229</b>
	<b>Appendix B – Serial port</b>	<b>231</b>
	<b>Appendix C – Error messages</b>	<b>233</b>
	<b>Appendix D – Z88 character set</b>	<b>237</b>
	<b>Appendix E – PipeDream file format</b>	<b>240</b>
	<b>Appendix F – Z88 specification</b>	<b>243</b>
	<b>Index</b>	<b>245</b>



---

# INTRODUCTION

<b>Section One – Getting started</b>	<b>3</b>
<b>Introducing the Z88</b>	<b>4</b>
Conventions in this manual	4
<b>Up and running</b>	<b>6</b>
Fitting batteries	6
Inserting the batteries	7
Initialise the Z88	8
Adjust the display	8
Set the clock	9
Try typing text	9
Switch off	10
<b>The Z88 applications and popdowns</b>	<b>11</b>
The applications	11
The popdowns	13
<b>Basic concepts</b>	<b>15</b>
The keyboard	15
The Index	18
Entering an application	19
Suspended activities	20
Using menus	20
Short cuts – ◇	23
Line editing	24
Memory low condition	24
Soft and hard reset	24
Help	25



---

# Section One

# Getting started

---

Start here to find out how to get your Z88 working for you.

This section contains four introductory chapters:

**Introducing the Z88** gives a foretaste of what the Z88 can do.

**Up and running** explains how to insert batteries, switch on, and start writing your first document on the Z88.

**The Z88 applications and popdowns** describes the programs provided in the Z88, to help you decide which you want to learn about first. These are then explained more fully in the later sections.

**Basic concepts** explains a little more about the components of the Z88: the keyboard, the display, and how the functions work.

---

# Introducing the Z88

---

The Z88 is a unique computer for several reasons.

For the first time in a machine of its size and portability it offers you a powerful productivity tool, PipeDream, capable of tackling the most demanding applications and providing all the capabilities normally only obtained by working with separate programs on much larger computers; it combines in one program most facilities provided by the best word processors, database programs, and spreadsheets.

To complement PipeDream, the Z88 comes complete with a range of utility programs, designed to anticipate any task you might wish to perform in the home or office; these include a clock, calculator, diary and organiser, and an alarm reminder.

The Z88 also avoids the problems of storing documents and applications long-term by providing battery-powered circuitry which will retain all the information in the computer for over a year while it is switched off. The batteries also maintain the correct time and date in an internal clock and calendar.

In addition, communication with larger computers is catered for by built-in transfer programs.

In no time, the Z88 will revolutionise your life by making it possible for you to work with the tools you need, wherever and whenever you want.

---

## Conventions in this manual

In this manual, anything displayed on the Z88 screen is shown in a computer typeface, such as

```
Name of file to save
```

Anything that you should type at the keyboard is shown in a different typeface to designate the keyboard keys; for example

```
You are invited to a party
```

The keys on the keyboard with a special function are shown in the text with key legends. So, for example, if you are asked to type

myfile **ENTER**

you would actually type the letters m y f i l e and then press the **ENTER** key.

In general, references to menu headings are in bold caps; for example **LAYOUT**

References to individual commands are in bold; for example **Save** or **Load**.

References to options displayed by a command are in italics; for example *Save only range of columns*.

---

# Up and running

---

This section will explain how to get your Z88 working for you as soon as possible. Once you have tried out the simple examples in the next few pages you should have a feel for what the Z88 can do for you, before proceeding to the later sections at your leisure.

---

## Fitting batteries

To run the Z88 you will need the following batteries:

- Four alkaline cells, Size AA, type MN1500 or LR6.

Other types of the same size can be used in an emergency, but we recommend the use of the leak-resistant alkaline type as these will keep your Z88 working for longer without needing replacement.

With these batteries an unexpanded Z88 will give about 20 hours of active computing, and the data will be preserved in the machine while it is switched off for up to a year.

For heavy indoor use the mains power unit is recommended.

**Note that the procedure described here is not the same as the one for replacing existing batteries. In this case refer to Appendix A.**

## Inserting the batteries

The four batteries are housed in a row in the battery compartment, under a flap on the rear of the Z88 case.

To insert batteries for the first time, use the following procedure:

① Remove the cover from the battery compartment on the back of the Z88 case, and insert one battery at each end of the compartment.

Make sure the batteries are fitted the correct way round, as indicated by the diagram in the battery compartment.

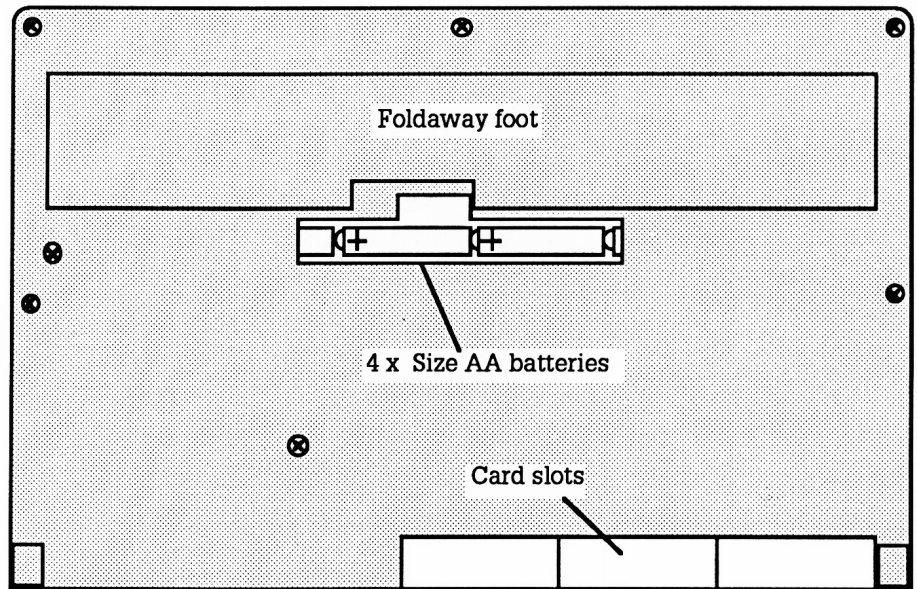

② Insert the remaining two batteries to make an 'A' shape above the case. Make sure that all four batteries are facing in the same direction, with the correct polarity.

Then push down on the two batteries so that they click into place.

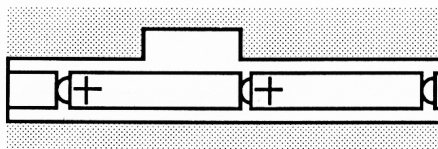

③ Replace the battery compartment cover firmly.

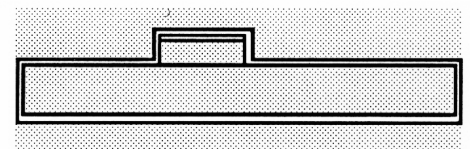

## Initialise the Z88

- ① Open the transparent cover to the card slots.
- ② Locate the reset button, which is situated behind a hole on the left-hand edge of the Z88 case.

③ Press the reset button twice, using an unbent paperclip to reach into the hole.

④ Close the card slot cover. This gives a hard reset, initialising the Z88 to make it ready for use.

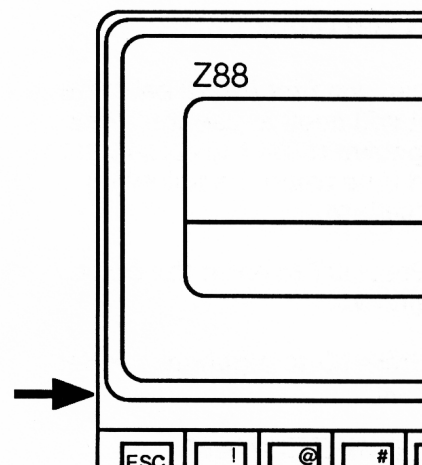
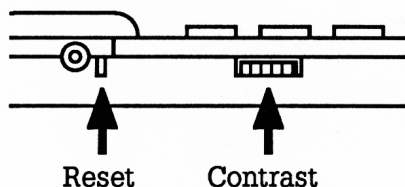

## Adjust the display

① Turn the contrast control as far towards the top of the Z88 case as it will go (ie clockwise).

② The screen should display a dark blue rectangle.

③ Gradually turn back the control until you can see the Z88 screen clearly.

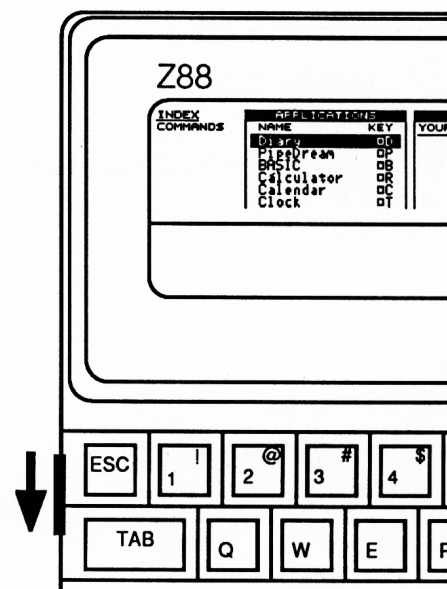
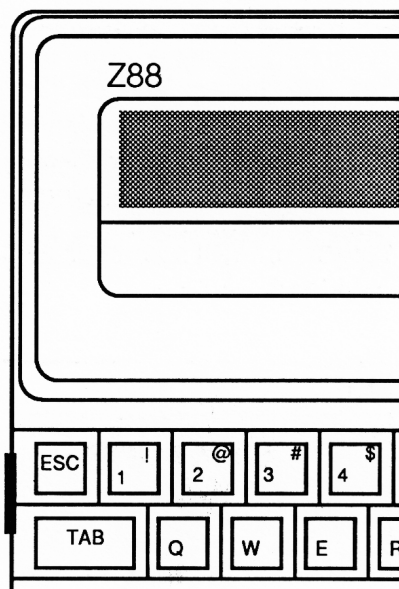
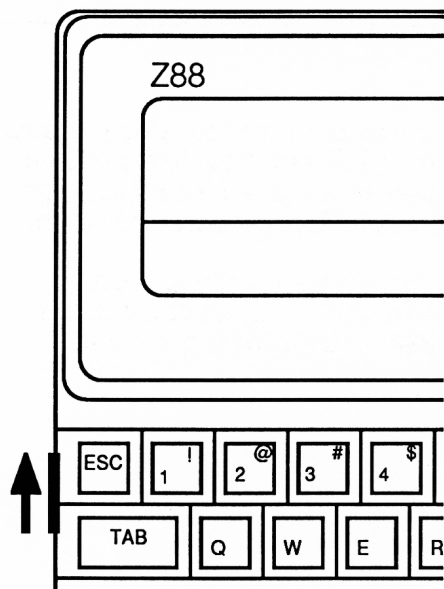



## Set the clock

When you first install batteries you will need to use the Clock popdown to set the correct date and time using the following procedure:

① Press **□T** to enter the clock popdown.

② Press **⇨** to highlight the *Set* option:



③ Press **ENTER** to enter the *Set* function, which displays the previous (incorrect) date and time, and will allow you to alter these to their correct values:



You can move the cursor between the time and date with **↑** and **↓**.

You can also move the cursor left and right along the digits with the **⇐** and **⇨** keys. Moving off the end of the date will position the cursor on the time, and vice versa.

④ Having positioned the cursor, simply type the correct time or date, using the numeric keys 0 to 9. The format of the new time and date should not change; if you type over the **'/'** or **':'** signs, move the cursor back with the **⇐** key and replace them.

When you have set the correct values, press **ENTER** to confirm them, and after about two seconds the correct time and date will be displayed.

Finally, press **ESC** to exit from the Clock.

## Try typing text

① Hold down the **□** key (at the bottom left of the keyboard) and press the **P** key, to enter PipeDream.

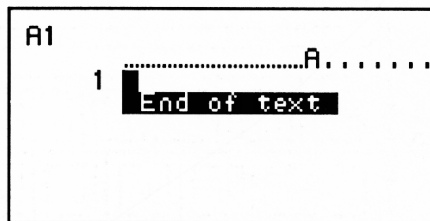

② Type *Dear Sir*, at the keyboard. Press the **DEL** key to delete mistakes. If you type more than will fit on one line, PipeDream will automatically lay out the text for you.

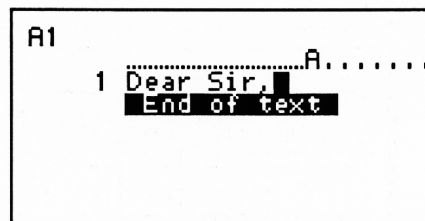

③ Return to the Index by pressing the **INDEX** key. Your letter will be kept as a suspended activity; go back to it by pressing **□P** again.

You are now ready to proceed with the examples of using the Z88 in the following sections.

## Switch off

**There is usually no need to worry about switching your Z88 off.**

If you do not type anything for several minutes the machine will automatically switch off to conserve power.

You should always switch your Z88 off before, for example, carrying it in a briefcase. This is because the keys may get pressed, disturbing what you were in the middle of doing, or keeping the Z88 on and wasting the batteries.

To switch off press both **SHIFT** keys simultaneously.

To switch the Z88 on again at any time, press both **SHIFT** keys simultaneously.

---

# The Z88 applications and popdowns

---

The Z88 comes with two types of built-in program, called **applications** and **popdowns**. For most of your work, you will probably use the **applications**, for writing text, setting up financial calculations, or organising information and appointments.

The **popdowns** perform simpler tasks, and are equivalent to desktop tools. They can be called up from within any application whenever you need them, and in the cases of the alarm clock, calculator and calendar, will generally be most useful for making a rapid check or record of information. So, in the middle of typing a letter, for example, you could use the Calculator to perform a quick calculation, and then return immediately to the letter.

You can keep several unfinished documents in your Z88 at once: when you return to one of them to continue working on it, everything will be exactly as you left it. The Z88 is designed to leave you free to do things in whatever order you wish, and whenever you want. It does the work, and leaves you free to get on with the thinking.

The next few pages will give an overview of what the Z88 applications and popdowns can do. The TUTORIAL, in Sections Two, Three, and Four, then gives fuller descriptions of each application and popdown, with examples of their use.

---

## The applications

The following applications are provided in the Z88:

### **Creating documents – PipeDream**

A typewriter may enable you to type in text, correct mistakes as you type them, and underline text, but as soon as you need to make revisions, you inevitably have to retype parts of what you have already written.

In **PipeDream** you can carry out proof corrections, sorting operations, and complex calculations with a few keystrokes, without you having to retype any of the text.

Some facilities, such as the ability to move blocks of text around, will be familiar to anyone who has already used another word processor. Other features, like the ability to put a list of items into numerical order or the ability to perform calculations on tables of values, are normally only found on specialist pieces of software specifically designed for these tasks.

### **Organising your time – Diary**

The Diary program provides a quick way of organising events, and keeping day-to-day information, such as expenses. Like a desktop diary, there is a page for each day, on which you can write engagements and other information. But the Z88 diary also caters for the likelihood that you might want to find something you wrote down on a previous occasion; if you cannot remember even the month of a particular exhibition, just search for 'exhibition' and the Diary will find the page for you. You can also print out entries of a certain type, which makes it easy to produce expense claims, or worksheets.

### **Writing a program – BBC BASIC**

The Z88 comes complete with the **BBC BASIC** programming language which will allow you to program the computer to carry out sequences of instructions. For example, if you wanted to process some complicated statistical data, or convert the format of a file, the simplest way to do this might be to write a program using BBC BASIC.

BBC BASIC is also an ideal language for learning to program, and many books on programming are available for use with it.

### **Talking to another computer – Terminal**

The Terminal application allows you to set up a conversation with another computer, using the VT52 standard. With a modem, this will allow you to access information databases via a telephone line.

### **Create a printer driver – PrinterEd**

The applications will print on any serial printer connected to the Z88, but to make full use of a particular printer's capabilities, such as special fonts and highlighting features, you may want to create your own driver selecting whichever features you require. The PrinterEd application makes this a simple task.

## **The popdowns**

Popdowns are programs you can call from within an application, to perform a service without breaking off from what you are doing.

### **Managing resources – Index**

The Index popdown is the key to all other Z88 applications and popdowns. From here you can call any other application or popdown, or resume an activity you suspended on a previous occasion. The Index also contains the Card Manager, which shows what memory cards or plug-in applications are present in the Z88, and allows you to insert or remove cards.

### **Performing rapid calculations – Calculator**

You can use the Calculator to make quick calculations – even if you are in the middle of doing something else at the time. Its features include ten memories, and a units-conversion facility. So, for example, you can convert from litres to gallons with a few key-presses.

### **Looking up dates – Calendar**

The Calendar means that you can plan your appointments for the coming weeks at a glance; and when you need to make a Diary entry, you can use the Calendar with the Diary to find the day you want immediately (see p. 68 for details).

### **Knowing the time – Clock**

The Clock will show you the time and date instantly, without your having to look away from whatever else you are doing.

All files and suspended activities are labelled with the time and date, so be sure that you have set the clock before you use the Z88.

### **Remembering appointments – Alarm**

The Alarm application allows you to set up a number of alarm reminders, with a given time and, if required, date. Each reminder can include a message, and reminders can be programmed to alert you at the same time every day, month, or other interval. You can even set the alarm to run a program.

**Working with files – Filer**

The Filer gives you access to the Z88 filing system, where you can store documents and BBC BASIC programs in the Z88 RAM, or for more permanent storage on an EPROM card. Although the filing system supports a flexible hierarchical directory structure, for simple applications directories can be ignored.

**Customise the Z88 – Panel**

The Panel is a set of controls for the Z88, allowing you to tailor the way that the keyboard, filing system, sound, and serial interface work to your own preferences.

**Transferring files to another computer – Import/Export**

The Import/Export popdown enables you to transfer documents to or from another computer, using a simple set of commands.

---

# Basic concepts

---

Before trying an application on the Z88, you need to be familiar with the basic concepts which are common to all applications. These involve selecting what you want to do, be it running an application or performing an operation within an application, and then carrying it out with the appropriate command from the keyboard.

---

## The keyboard

The Z88 keyboard looks like a normal typewriter keyboard with the familiar *qwerty* arrangement of letters.

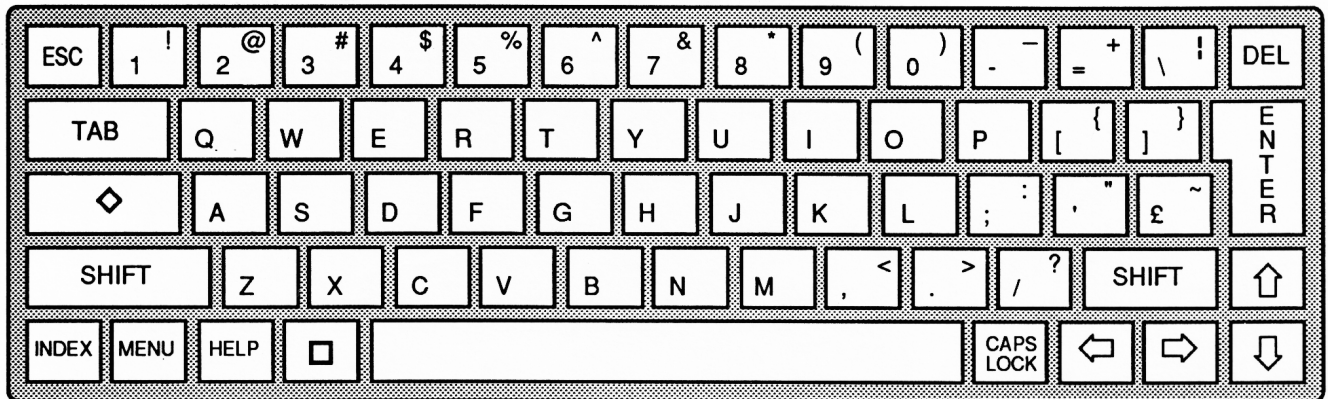

There are some additional keys on each side of the keyboard which have the special functions explained below.

### The letter and number keys

Press the letter keys alone to give the lower-case letters, or with **SHIFT** to get capitals. You can get capitals without needing to hold down **SHIFT** by pressing **CAPSLOCK** – see below.

Press the digit keys on the top row of the keyboard to give the digits, or with **SHIFT** to give the symbol above each digit on the key.

Note that, unlike on some typewriters, the letter O is quite different in meaning from the digit 0, and the letter l (lower-case L) from the digit 1.

**On the left-hand side of the keyboard:**

- ESC** will normally cancel what you are currently doing, and go back to the most appropriate point just before.
- TAB** is like the tabulate key on a typewriter. Use it for making columns of figures, or arranging tables.
- MENU** enables you to select which of the Z88's operations you want to carry out. These are explained in greater detail in the section **Using menus** on p. 20.
- INDEX** will return you to the Index from within an application.
- HELP** gives you a display of information about the action you are currently carrying out. Further information is then available on related topics.
  - introduces a short cut to calling an application or a popdown.
  - ◇ introduces a short cut for carrying out an operation within an application or popdown. A list of the most useful of these operations is given on the Single key functions card, above the Z88 keyboard.

**On the right-hand side of the keyboard:**

- DEL** rubs out the last character you typed at the keyboard.
- ENTER** is normally typed at the end of a line to confirm what you have just typed, or to go to the beginning of the next line, like the carriage return on a typewriter.
- ↑, ↓, ←, → move the cursor up, down, left or right on the screen.

**Caps lock modes**

Two caps lock modes are available which determine the way that the **SHIFT** key operates. The mode selected is indicated by a symbol at the bottom right-hand corner of the screen. The state of the caps lock mode is stored with each application, so you can, for example, keep one mode set up for PipeDream and another for BASIC. The operation of each mode is as follows:



- ◆ **CAPSLOCK** selects Normal Caps mode. The letter keys give capitals, irrespective of the **SHIFT** key. Displays:

**CAPS**

- **CAPSLOCK** selects Inverted Caps mode, giving capital letters normally, and lower-case with the **SHIFT** key. Displays:

**caps**

- CAPSLOCK** switches on and off the selected mode.

### Special characters

- ◆ ' gives `` (grave accent), and ◆SPACE gives an exact space, displayed as '... '.

### Cleaning the keyboard

The keyboard should be kept free from dust by cleaning it periodically with a damp lint-free cloth, or sponge. Solvents should not be used.

## The Index

The Index popdown allows you to call up Z88 applications or popdowns, or to return to any activity that you were previously working on.

To see the Index screen at any time, press the **INDEX** key at the lower left of the keyboard. To return to an application from the Index, press **ESC**.

The components of the Index screen are identified below:

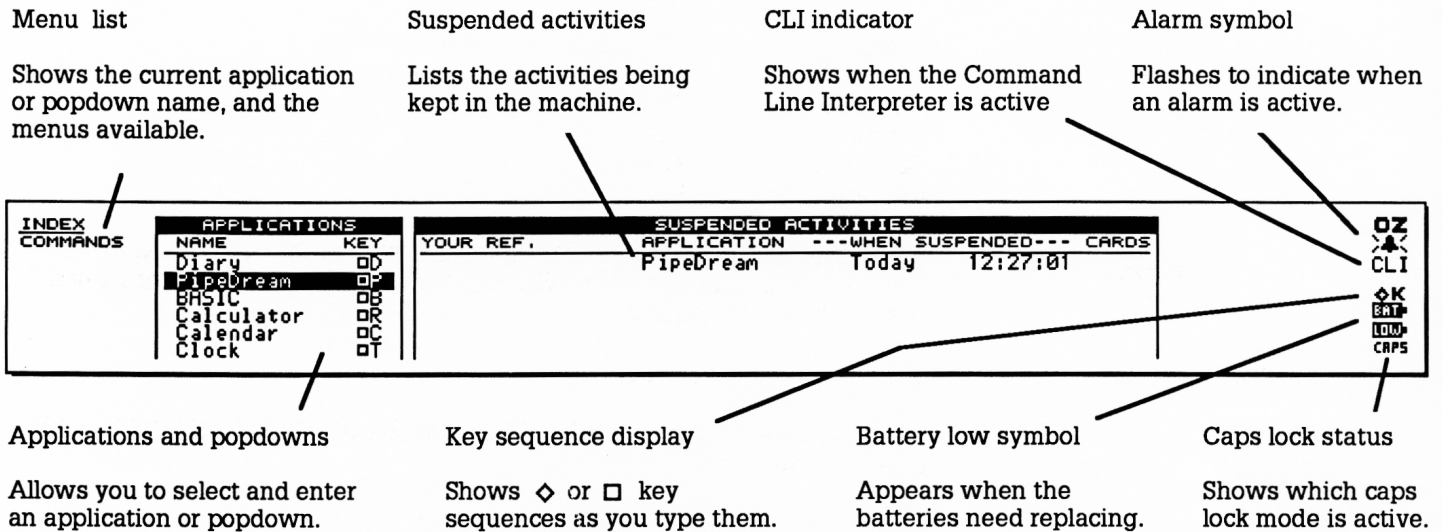

The right-hand edge of the screen is reserved for status information from the Z88 operating system. It displays OZ when the Z88 is ready for use.

## Entering an application

To enter an application, or a popdown, you simply have to select its name on the APPLICATIONS menu by moving the highlighting bar up and down with the cursor keys  $\uparrow$  and  $\downarrow$ :

Diary	<input type="checkbox"/> D
PipeDream	<input type="checkbox"/> P
BASIC	<input type="checkbox"/> B
Calculator	<input type="checkbox"/> R
Calendar	<input type="checkbox"/> C
Clock	<input type="checkbox"/> T
Alarm	<input type="checkbox"/> A
Filer	<input type="checkbox"/> F
PrinterEd	<input type="checkbox"/> E
Panel	<input type="checkbox"/> S
Terminal	<input type="checkbox"/> V
Imp-Export	<input type="checkbox"/> X

When the bar reaches the bottom of the screen, the list scrolls up to show the remaining options. Having selected the one you want press the **ENTER** key to enter it.

### Creating a new activity

Entering PipeDream or BBC BASIC from the Index APPLICATIONS list creates a new, blank document.

For example, to enter PipeDream, starting with a new blank document, move the highlighting bar until **P i p e D r e a m** is selected, and press the **ENTER** key; you will then see the PipeDream screen:

```

PIPEDREAM A1
BLOCKS
CURSOR
EDIT
FILES
LAYOUT
OPTIONS
PRINT
1 .....A.....B.....C.....D.....E.....F
End of text
OZ

```

## Suspended activities

If you return to the Index after creating a document in PipeDream (or writing a program in BBC BASIC), your activity will be suspended, and you will see it listed in the list of **SUSPENDED ACTIVITIES**. This shows the time and date you were last working on the document under the heading **WHEN SUSPENDED**, and if a name has been given to the document (with the PipeDream **◇FC** or **◇FL** commands, or the BASIC **\*NAME** command), the name will be shown in the column headed **YOUR REF**. You can keep as many PipeDream and BBC BASIC suspended activities as you want, subject to the available memory.

### Re-entering a suspended activity

You can re-enter a suspended activity by selecting it on the list of **SUSPENDED ACTIVITIES**. Move the highlighting bar across with the **⇨** key if necessary, and then press the **ENTER** key. Alternatively, pressing **□P** or **□B** repeatedly will enter each PipeDream or BBC BASIC activity in turn.

### Killing activities – **◇KILL**

Each suspended activity does, of course, use up some memory space; some for the document you are working on, plus a small overhead needed by the application. You can therefore kill activities you no longer need to work on in order to free the memory space. Save the document (or program) first if you may need it again.

To kill a suspended activity, select it on the **SUSPENDED ACTIVITIES** list with the cursor, and type **◇KILL**. The activity will be removed from the list, and any document (or program) associated with it will be lost.

---

## Using menus

The Z88 applications, and some popdowns, use menus to show you what operations are available at any stage, and to give you a simple way of choosing the one you want from among them. In keeping with the philosophy of the Z88, menus free you from having to remember cryptic sequences of commands to be typed from the keyboard, and allow you to do what you want as quickly as possible.

The items on each menu all relate to one particular type of operation. For example, all the operations to do with printing are listed on a **PRINT** menu. The menu headings are shown on the Menu List, which is displayed on the left-hand side of the screen under the name of the application or popdown.

To use menus you have to:

- ① Select the menu you want from the menu list.
- ② Select the operation you want to perform from that menu.
- ③ Execute the operation.

These three steps are now explained in greater detail.

### Selecting a menu

As an example of using menus, try using the menus in the PipeDream application. First enter PipeDream from the Index as already described.

The menus available in any application are listed at the left-hand side of the screen, under the application name.

For example, the menus in PipeDream are given under the heading **PIPEDREAM**. Each title refers to one type of operation you can perform with PipeDream. For example, the first menu, the **BLOCKS** menu, contains operations you can perform on a block of text.

Pressing the **MENU** key will display this menu, and **BLOCKS** will be highlighted in bold letters on the Menu List. To look at a menu further down the list, press the **MENU** key until you reach it. If you go past the menu you want, keep pressing the **MENU** key until it circles back around to the top of the list.

PIPEDREAM	<b>Mark Block</b> ◊Z	Search	◊BSE	Word Count	◊BWC	<b>MENU</b>	<b>OZ</b>
<b>BLOCKS</b>	Clear Mark ◊Q	Replace	◊BRP	New	◊BNEW	ADVANCE	
CURSOR	Copy ◊BC	Next Match	◊BNM	Recalculate	◊A	◄ ◄ ◄ ◄	
EDIT	Move ◊BM					SELECT	
FILES	Delete ◊BD					ENTER	
LAYOUT	Sort ◊BSO					ACTION	
OPTIONS	Replicate ◊BRE					ESC	
PRINT						RESUME	

For example, to select the **FILES** menu, you need to press the **MENU** key three more times. You can always check which menu is displayed by the title in bold on the Menu List.

PIPEDREAM	<b>Load</b>	◊FN	Next File	◊FN	MENU	OZ
BLOCKS	Save	◊FP	Previous File	◊FP	ADVANCE	
CURSOR	Name	◊FC	Top File	◊FT	◄ ◃ ◅ ◆	
EDIT			Bottom File	◊FB	SELECT	
<b>FILES</b>					ENTER	
LAYOUT					ACTION	
OPTIONS					ESC	
PRINT					RESUME	

### Selecting an operation

You select a menu item by moving the highlighting bar with the cursor keys ◀▶⏶⏷ until the operation you want is highlighted.

### Executing the operation

To perform the highlighted operation, simply press the **ENTER** key.

For example, on the **BLOCKS** menu example shown above, press the **ENTER** key to perform the **Mark Block** operation.

### Options

Many operations give you a list of options before actually carrying out the command. The **Save** command, on the **FILES** menu, is an example; press ⏷ to highlight the **Save** command. When you press the **ENTER** key you will see the following prompts:

```
Name of file to save      █
Save only range of columns  No
Save selection of rows    No
Save marked block        No
Save plain text           No
```

In this case you can simply type in a file name, such as

```
Name of file to save      Myfile█
```

and press the **ENTER** key to carry out the **Save**.

The other options under the **Save** command have only two possibilities each, **Yes** and **No**. You can alternate between them in two different ways:

- ① Type Y for **Yes** and N for **No** as appropriate.
- ② Use the **Next Option** or  $\diamond$ J command to display the alternative value. (With options which have specific values,  $\diamond$ J will restore the default; see **Setting the options**, p. 103, for more details.)

### Escaping from an operation

If you decide against performing an operation from the menu, press the **ESC** key and the menu will disappear from the screen.

It may take you a little while to become familiar with using the menu operations to carry out your wishes, but once you have mastered menus you will be able to use all of the applications on the Z88 without difficulty.

---

## Short cuts – $\diamond$

Menus make it easy to locate what you want to do even if you are not familiar with an application. But with a little experience you will find you know exactly which operation you want to carry out, and so will appreciate the short cuts which allow you to carry out any action without going through a menu.

Each operation can be called up by typing the special  $\diamond$  key (called 'diamond'), followed by a sequence of one or more letters. When you type a  $\diamond$  sequence, the operation will be carried out instantly, no matter what you were doing in the application. If you do not keep the  $\diamond$  key held down while you are entering a  $\diamond$  sequence, the letters are shown at the right-hand side of the screen as a reminder.

The short cuts are shown on each menu so that you can refer to them if necessary. For example, the short cut for the **Save** operation, shown on the **FILES** menu above, is  $\diamond$ FS. Also, the most useful of these operations are shown on the list of key functions above the Z88 keyboard.

**Note:** Normally  $\diamond$  and  $\square$  may be used either by holding them down whilst typing the sequence, or by pressing and releasing them and then typing the sequence. There are two exceptions to this; these are  $\diamond$ ESC and  $\square$ ESC where they must be held down.

## Line editing

In most situations where you are entering a line of text in the Z88, such as in response to a prompt, the following commands are available to make corrections and alterations to what you are typing:

- ←, → moves the cursor left and right
- ◊←, ◊→ moves the cursor to the beginning or end of a line
- DEL deletes the previous character
- SHIFT DEL deletes the character at the cursor position
- ◊D deletes to the end of the line
- ◊T deletes a word

## Memory low condition

When you have almost filled the Z88 memory, with applications or data, the menu-selection of commands is automatically disabled to conserve memory. The highlight bar disappears, and the prompt display, at the right-hand side of all menu screens, changes to indicate that menu commands can no longer be selected with the cursor keys:

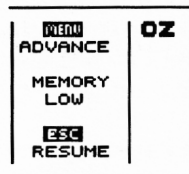

In the memory-low condition the command short cuts must be used until enough memory has been freed from the machine.

## Soft and hard reset

### Soft reset

In the unlikely situation of the Z88 not responding to any keyboard input it can be given a soft reset. This will remove all the applications running in the Z88, and clear any temporary work space being used by the operating system, but should retain all files.



To give a soft reset, press the reset button twice. The display will briefly show

**SOFT RESET . . .**

and then return to the Index. The operating system does its best to retain all files in the internal or external memory, and usually succeeds.

### **Hard reset**

Hard reset completely initialises the Z88, clearing all memory, losing all files, and resetting the clock. Hard reset is described in **Initialise the Z88**, p. 8. After a hard reset the Z88 will display

**HARD RESET . . .**

---

## **Help**

The Z88 contains a Help system with highly-structured information on many operations and facilities provided by the machine. The problem new users of a computer often face is that they need to find out how to do something but are not quite sure where to look. The Z88 Help system overcomes this problem by allowing you to 'browse', from Help information on one topic to information on related ones which might also provide the information you require. The help information is limited on the basic machine, but there is the provision of extending it with a Help application card.

### **Getting help**

To find out information about a particular topic all you have to do is press the **[HELP]** key at the bottom left-hand side of the keyboard. The Help system will then automatically give you information on the menu or operation within the application you are currently using.

### **Browsing within Help**

The cursor keys **←** **→** **↑** **↓** and the **[HELP]** key allow you to obtain more information, as shown on the Help screen.

### **Returning to your application**

To exit from the Help system and return to your application, press the **[ESC]** key.



---

# TUTORIAL

<b>Section Two – Using PipeDream</b>	<b>31</b>
<b>Starting PipeDream</b>	<b>32</b>
The structure of PipeDream	33
<b>Designing a party invitation</b>	<b>37</b>
Starting PipeDream	37
Typing text	37
Deleting	38
Word wrap	38
Adding text	38
Starting a new paragraph	39
Columns	40
Replacing text	40
Inserting a line	41
Adding styles to text	41
Altering the layout of text	42
Saving your document	43
Loading a document	44
Printing the document	44
What next?	45
<b>Compiling a name and address list</b>	<b>46</b>
Preparing the document	46
Setting up headings	47
Entering some information	48
Saving the document	50
Sorting the information	50
Finding information	52
Help with searching	53
Printing information	53
Printing selected rows	54

<b>Calculating home expenses</b>	<b>56</b>
Designing the table	56
Moving around the document	56
Labelling the table	57
Entering the rates	58
Referring to slots	58
Replicating values	59
Other expenses	60
Monthly totals	60
Replicating slot references	60
Percentage expenditures	61
Changing the format	63
What you have learnt	64
<b>Section Three – Using the Diary</b>	<b>65</b>
Entering the Diary	65
Making a Diary entry	66
Moving between days	66
Searching for Diary entries	67
Using the Calendar and Diary together	68
<b>Section Four – Using the popdowns</b>	<b>69</b>
Using popdowns	69
<b>The Calculator – □R</b>	<b>70</b>
Entering numbers	71
Display format	72
Constants	72
Storing and Recalling	72
Percentages	73
Converting units	74
<b>The Calendar – □C</b>	<b>75</b>
Searching for a day	76
Active days	76
<b>The Clock – □T</b>	<b>77</b>
<b>The Alarm – □A</b>	<b>78</b>
Alarm options	78
Clearing alarms	79

---

<b>The Filer – □F</b>	<b>80</b>
Entering the Filer	81
File names	81
Giving Filer commands	82
Selecting files	83
Filer commands	84
<b>The Panel – □S</b>	<b>87</b>
Altering the panel	87
Panel options	87
<b>Import/Export – □X</b>	<b>90</b>
Using Import/Export	90
Import/Export protocol	91
<b>The Index – □I</b>	<b>92</b>
The Index screen	92
Entering an application	93
Suspended activities	93
Cards	94
RAM cards	95
EPROM cards	96
Application cards	98



---

## Section Two

# Using PipeDream

---

This section will familiarise you with all the essential facilities provided by PipeDream, through a series of three simple worked examples:

- Design a party invitation, using PipeDream's text editing and page layout facilities.
- Set up a name and address list, using PipeDream's ability to organise information.
- Calculate home expenses, using PipeDream's facilities for working with tables of figures.

---

# Starting PipeDream

---

Before trying the sample applications using PipeDream, this section shows how to start PipeDream, and introduces the fundamental concepts necessary to an understanding of how to work with it.

First start PipeDream with a blank document from the Index. To do this:

- ① If you are not already in the Index, press the **INDEX** key.
- ② Select PipeDream from the Index APPLICATIONS list. Press **↩** to move into the APPLICATIONS list, if necessary, and press **↓** or **↑** until **P i p e D r e a m** is shown highlighted.
- ③ Press the **ENTER** key to enter PipeDream.

You will see the PipeDream opening screen, confirming that you have selected the PipeDream application.

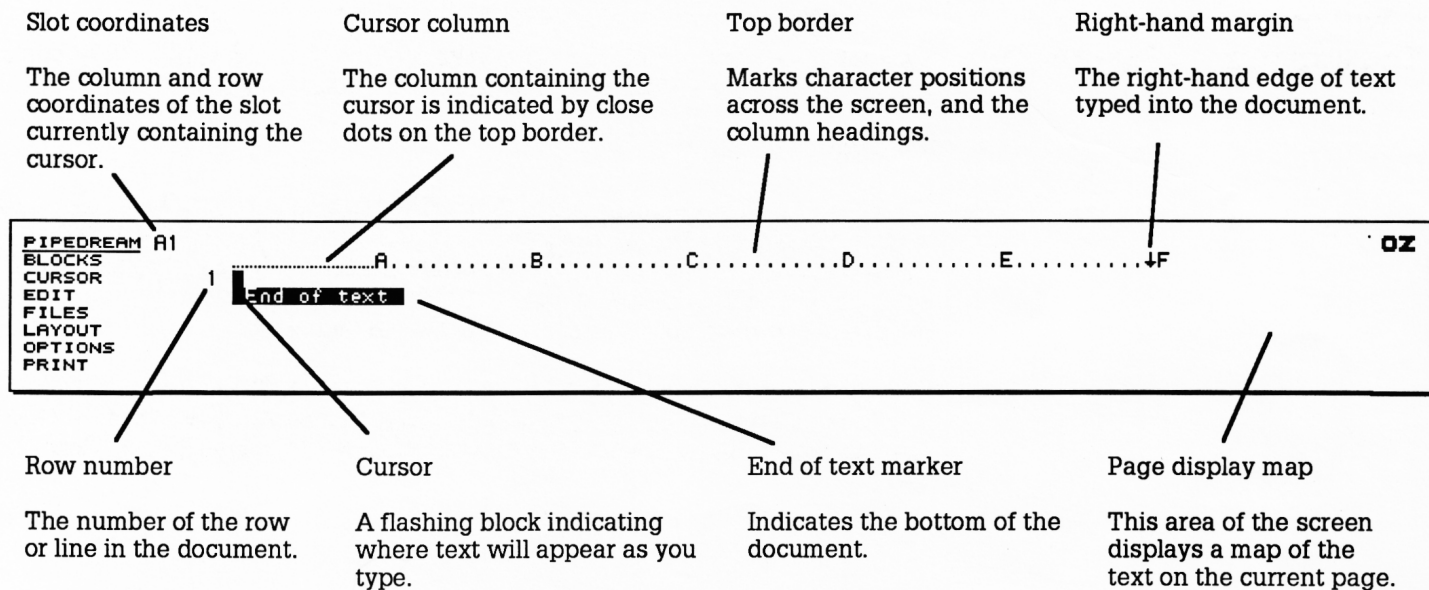



For clarity, the subsequent diagrams in this chapter show the central portion of the screen only.

### Page display map

The page display map gives you an overall view of the current page of the document you are working on in PipeDream. Each character in the document is represented by a single dot in the map, enabling you to see the layout of the whole page and, if necessary, to adjust the layout to improve the appearance.

At any time the lines on the map corresponding to those displayed on the PipeDream screen are indicated by a vertical bar at the right-hand side of the map:

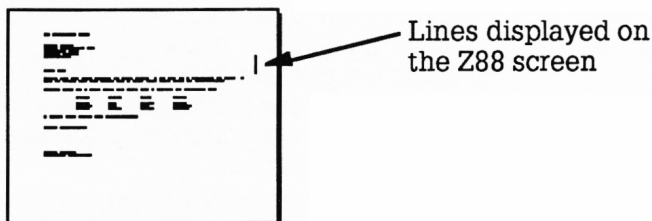

---

## The structure of PipeDream

To make best use of PipeDream it is important to understand some basic principles of how PipeDream documents are constructed.

### Rows and columns

Every document is divided into rows or lines, numbered 1, 2, 3... etc, and one or more columns, labelled with letters A, B, C... etc. Initially the document has 6 columns, labelled A to F, each of which is 12 characters wide, but commands are available for you to alter the widths of individual columns or to alter the number of columns:

The part of a document lying in one row and one column is called a slot. A slot is referred to by its column label and its row number; for example, the following diagram shows slot D3 highlighted by the highlighting bar:

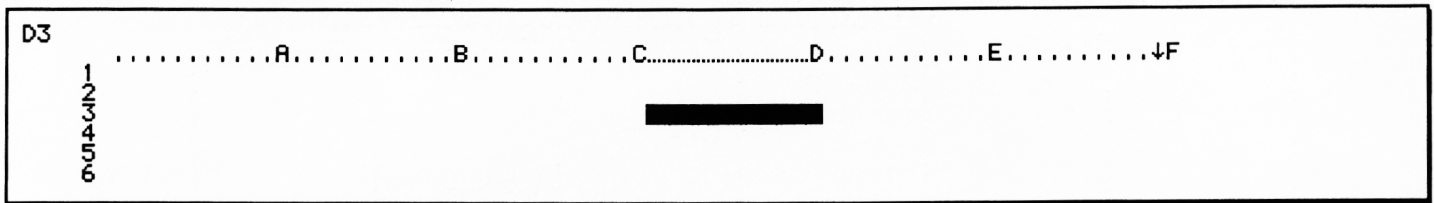

The coordinates of the slot containing the cursor are shown at the top left of the PipeDream screen, and the column containing the cursor is identified by closely-spaced dots on the top border.

The right-hand margin is indicated by the ↓ symbol on the top border, and normally all columns have their right-hand margins at the right-hand edge of the screen.

Much of the power and flexibility of PipeDream comes from the two different types of slot which you can create and combine within a single document: *text slots* and *expression slots*. Each type of slot can contain up to 240 characters.

### **Text slots**

Text slots are used for entering and editing continuous text, such as the body of a letter, a technical paper, or a novel.

When working with text, the columns in PipeDream behave as if they are on different layers, like separate overlapping sheets of paper. For example, the initial column format could be represented by the following diagram:

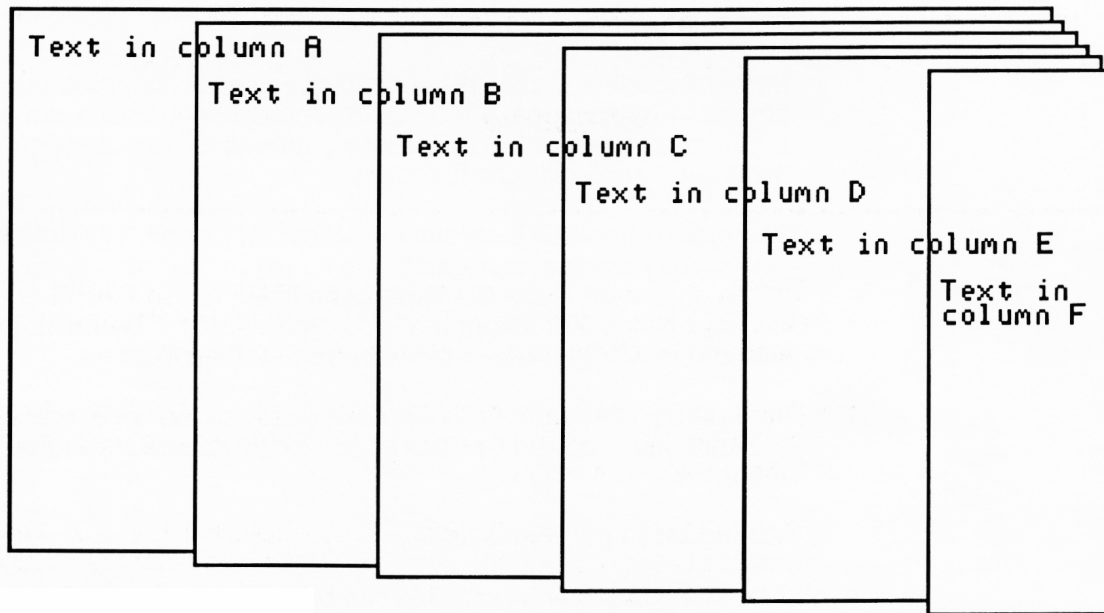

Text typed into column A behaves as if it is on the bottom layer, which is 72 characters wide; it will 'show through' the other layers, unless they contain text or expressions in the same row.

Text typed into column F behaves as if it is on the uppermost layer, which is only 12 characters wide

When text is typed into a text slot it will automatically wrap around to the start of the next row in the same column when the cursor reaches the right-hand margin for that column (unless wrapping has specifically been turned off).

### **Formatting**

If justified text has been selected, from the Options Page, lines will be padded with spaces so that the right-hand margin is even. The layout of a document can be altered simply by moving the right-hand margin, and then reformatting the text paragraph by paragraph.

By giving each column a different right-hand margin, independent columns of text can be created within the same document. With a little practise you will find that PipeDream is capable of creating quite complex multi-column page layouts.

### **Expression slots**

Expression slots, on the other hand, are used for creating tables of figures or information, often called spreadsheets. These can contain mathematical expressions, including references to other slots in the document, and scientific functions.

The main difference between expression slots and text slots is that once you have typed the expression into an expression slot, what is displayed in the document is not the expression itself, but the result of evaluating the expression. For example, if you typed  $1.15 * 300$  into an expression slot, the result 345 would be displayed in the document.

For spreadsheet work you can make all slots work as expression slots by default by setting the Options Page Text/Numbers setting to Numbers; see p. 140.

### **Mixing text and expressions**

Text slots and expression slots can be mixed in the same document; so a letter could include a table of financial calculations automatically added together by PipeDream, or a company business plan could incorporate a spreadsheet within the descriptive text to show financial predictions.

Values from expression slots can be included within formatted text in text slots using '@-fields'. This is convenient if, for example, you want a letter to refer to the result of a particular calculation.

### **The examples**

The concepts of rows and columns, text slots and expression slots, and formatting text, are illustrated by the following three practical examples in the use of PipeDream.

---

# Designing a party invitation

---

This chapter will explain how to:

- Type in text
- Make corrections to the text you have entered
- Create bold and underlined text
- Alter the layout of text
- Save the document
- Print the document

---

## Starting PipeDream

This example shows how PipeDream can be used in a typical word-processing application. To enter PipeDream from the Index starting with a blank document, select PipeDream from the Index, and press the **ENTER** key.

---

## Typing text

Type the following:

You are invited to a beano.

Notice that the cursor moves to the right as you type. The next character you type will always be typed at the position indicated by the cursor.

A short time after you stop typing, you will see the page map, on the right-hand side of the screen, change to show the new layout of text on your page.

```

A1 .....A.....B.....C.....D.....E.....↓F  -----
1 You are invited to a beano.█
  End of text

```

## Deleting

Press the **DEL** key at the top right-hand side of the keyboard, until the word `beano` disappears.

**DEL** backspaces the cursor over the text you have typed, removing it from the page.

## Word wrap

Type the word `party` and then continue to type the paragraph shown below. If you make a mistake, use the **DEL** key to correct it.

When your typing reaches the right-hand margin, indicated by the ↓ symbol on the top border, just keep typing and PipeDream will automatically carry words over to the start of the next line.

You are invited to a party to celebrate the creation of my first document with the Z88 computer. Champagne will be provided.

## Adding text

PipeDream starts in Insert mode, although you also have the option of working in another mode called Overtyping mode. You can change modes with the **Insert/Overtyping** command; see p. 119.

In Insert mode, text is always added at the position indicated by the cursor. You can add text simply by moving the cursor to the point where you want the text added, and then typing. The cursor is moved around on your document using the four arrow keys, **←**, **→**, **↑**, **↓** at the bottom right-hand side of the keyboard.

Position the cursor after the word `champagne`, on the second line of the text you have just entered, press the space bar, and add the phrase:

and smoked salmon

The original text will move apart to make room for the new text, and words will wrap around to the next line at the right-hand margin to ensure that the altered text is correctly formatted.

```

A2
.....A.....B.....C.....D.....E.....+F
1 You are invited to a party to celebrate the creation of my first
2 document with the Z88 computer. Champagne and smoked salmon will be
3 provided.
   End of text

```

## Starting a new paragraph

After adding the new text press the `ENTER` key. `ENTER` moves the cursor to the beginning of the next line.

Press `ENTER` twice more to leave a blank line and move the cursor down to row 5 on the page. Type the following:

Sunday 28th February at 12 o'clock.

You can use the `ENTER` key to end paragraphs, insert blank lines, and separate items in a list.

```

A5
.....A.....B.....C.....D.....E.....+F
1 You are invited to a party to celebrate the creation of my first
2 document with the Z88 computer. Champagne and smoked salmon will be
3 provided.
4
5 Sunday 28th February at 12 o'clock.
   End of text

```

## Columns

The page you are working on is divided into six columns, each 12 characters wide, shown by the rows of dots and the letters A to F on the top border of the screen. These provide the equivalent to tab positions on a typewriter.

With the cursor still on row 5, press **TAB** exactly five times. The cursor will move to the left-hand edge of each column in turn until it reaches the left-hand side of the column labelled 'F'. Notice that as the cursor moves into each blank slot, text overlapping the slot is hidden. Now type in the text:

RSVP

The text will be positioned near the right-hand side of the sheet, opposite the text already on row 5.

```

F5
.....A.....B.....C.....D.....E.....↓F
1 You are invited to a party to celebrate the creation of my first
2 document with the Z88 computer. Champagne and smoked salmon will be
3 provided.
4
5 Sunday 28th February at 12 o'clock.                RSVP
End of text

```

You can move to the previous tab position by holding down the **SHIFT** key and pressing **TAB**. Try doing this to move the cursor back into column A, at the left-hand side of the screen.

## Replacing text

You can remove characters from the middle of a line by using the **Delete Character** command which you can give either using the **EDIT** menu, or by holding down the **SHIFT** key and pressing **DEL**.

Now you decide to change the day of the party to Saturday 28th February. Move the cursor across to the **S** of **Sunday** with the cursor keys. Then, hold down the **SHIFT** key and press **DEL**; the **S** will be deleted. Keep pressing **SHIFT DEL** until the word **Sunday** is removed. Then, type in the word **Saturday** to replace it.



## Inserting a line

Now add a heading to the invitation. To do this, you first need to insert two blank lines at the top of the page.

Move the cursor up to the first line of your document, row 1, by pressing  $\uparrow$ .

Now give the **Insert Row** command. You can do this either using the **EDIT** menu, or by typing  $\diamond N$ . A blank line will be added where the cursor was, and the remaining lines of the document will be moved down on the page.

Type  $\diamond N$  again to give two blank lines at the top of the page. Then type in the following text:

A Once-in-a-lifetime Party

```

A1 .....A.....B.....C.....D.....E.....+F ..... |
1 A Once-in-a-lifetime Party█
2
3
4 You are invited to a party to celebrate the creation of my first
5 document with the Z88 computer. Champagne and smoked salmon will be
6 provided.

```

The bottom line of your document will not be visible as it is off the bottom of the screen. You can make it scroll into view by moving the cursor down with the  $\downarrow$  key. Move the cursor back to the top line with the  $\uparrow$  key before continuing with the example.

## Adding styles to text

You can emphasise key phrases in your text by changing the style to bold, underlined or italics. This is achieved by selecting one of the highlight commands from the **PRINT** menu, or by typing one of the following highlight commands:

Command	Effect	Highlight code
$\diamond PU$	for underlined text	1
$\diamond PB$	for bold text	2
$\diamond PI$	for italic text	4

Type the command once at the beginning of the text you want to emphasise, and give the same command at the end of the text you want to emphasise, to switch back to normal text.

To emphasise the heading of the invitation, move the cursor to the beginning of the heading with the  $\leftarrow$  key. Then type  $\diamond$ PB. A '2' symbol will be inserted before the text to indicate that a highlight code 2 has been inserted. Move to the end of the heading with the  $\rightarrow$  key, and type  $\diamond$ PB again. Another '2' symbol will be inserted. Now move the cursor down to the next line with the  $\downarrow$  key and the heading will be displayed bold on the screen.

When you move the cursor onto the line containing highlights, the codes are displayed as highlighted numbers  $\blacksquare$  to  $\boxtimes$  so that you can edit them, or delete them, just like any other text characters. When you move the cursor onto another line, the effect of each highlight is shown on the screen, just as it will appear when printed out. (Italic text is displayed as tiny characters.)

## Altering the layout of text

You can alter the layout of one or more lines of text in your document with one of the **Align** commands on the **LAYOUT** menu. For example, to centre a line of text, you move the cursor onto that line and then select the **Centre Align** command from the **LAYOUT** menu. Alternatively, you can type  $\diamond$ LAC.

Move the cursor onto the line containing the heading of the party invitation, if it is not there already, and type  $\diamond$ LAC. You will see the heading become centred on the page map (which always shows you the format of the page as it will appear when printed). The actual line of text will be centred on the document when you move the cursor onto the next line.

```

A2
.....A.....B.....C.....D.....E.....+F  _____ |
1
2
3
4
5
6
7
8
9
10
11
12
13
14
15
16
17
18
19
20
21
22
23
24
25
26
27
28
29
30
31
32
33
34
35
36
37
38
39
40
41
42
43
44
45
46
47
48
49
50
51
52
53
54
55
56
57
58
59
60
61
62
63
64
65
66
67
68
69
70
71
72
73
74
75
76
77
78
79
80
81
82
83
84
85
86
87
88
89
90
91
92
93
94
95
96
97
98
99
100

```

A Once-in-a-lifetime Party

You are invited to a party to celebrate the creation of my first  
document with the Z88 computer. Champagne and smoked salmon will be  
provided.

## Saving your document

Once you have finished working on a document it is a good idea to save it as a file to the Z88 RAM. You will then be able to find it again without difficulty at a later date, and there is the added advantage that documents saved to the filing system take up less space and are more secure than documents left within PipeDream.

You can save a copy of your document into the Z88 filing system by selecting **Save** from the **FILES** menu:

- ① Press the **[MENU]** key until the **FILES** menu is displayed on the screen.
- ② Press the **↓** key to highlight the **Save** command.
- ③ Press **[ENTER]** to select the **Save** command.

The **Save** command optionally allows you to save only part of your document, and therefore prompts with the following questions:

```
Name of file to save           █
Save only range of columns    No
Save selection of rows       No
Save marked block            No
Save plain text               No
```

Type in the name *Invitation* as the name of the file to be saved, so that the top prompt becomes

```
Name of file to save           Invitation█
```

and press **[ENTER]**, since on this occasion you do not need to select any of the other options.

A copy of the document will be saved with the name *Invitation* in the Z88 filing system. You will see the file **Invitation** listed if you select the Filer by typing **□F**. Press **[ESC]** to return to PipeDream.

If at some stage you expand the Z88 with a RAM card, you can save a document to the extra RAM by referring to it in the file name as, for example:

```
:RAM.1/Invitation
```

## Loading a document

Try loading back the document you have just saved using the PipeDream **Load** command.

First clear the invitation from PipeDream by giving the **New** command from the **BLOCKS** menu. If you have altered the document since you saved it, the prompt

**Overwrite text?**

will be displayed at the top of the display, to give you the chance to go back and save your changes. Press **Y** to clear the document.

Then select the **Load** command from the **FILES** menu. As in the case of the **Save** command, fill in the file name in the list of options

**Name of file to load** **Invitation**█

and press **ENTER** to load the file. You should see the invitation exactly as you saved it.

---

## Printing the document

If you have a printer connected to the Z88, you can print out a copy of the invitation with the following procedure:

- ① Select the **PRINT** menu by pressing the **MENU** key until **PRINT** is highlighted on the Menu List.
- ② The **Print** operation may already be highlighted as it is the first item on the menu; otherwise use the cursor keys to select it.
- ③ Press **ENTER** to give the **Print** command.
- ④ Press **ENTER** again to ignore the **Print** options and print the invitation.

You can repeat the procedure to print as many copies as you want.

**A Once-in-a-lifetime Party**

You are invited to a party to celebrate the creation of my first document with the Z88 computer. Champagne and smoked salmon will be provided.

Saturday 28th February at 12 o'clock

RSVP

To get bold and underlined text to print correctly you may need to use the Printer Editor; see **Section Nine – The Printer Editor**, p. 187.

**What next?**

You have just seen how the Z88 makes it a simple matter to write text, correct mistakes, alter the layout, and print a document.

The Z88 also enables you to compile a catalogue of information, as demonstrated in the next worked example.

---

# Compiling a name and address list

---

This example shows how you can enter any type of information such as a library catalogue, a book index or bibliography, or a name and address list into the Z88 using PipeDream.

You will learn how to:

- Enter information
- Find any particular information you want
- Organise the information
- Print out all, or a selection, of the information in an orderly table

---

## Preparing the document

Because you are going to enter lists of information, rather than a block of text for formatting into a document, you should first alter the *Wrap* option on the **Options Page** so that words do not wrap around onto the next line when they reach the right-hand margin.

Select the **Options Page** by typing  $\diamond O$ . You will see a display showing the different options you can select for your document, and information about the document.

Move the cursor down to the wrap option by pressing  $\downarrow$  until the cursor is opposite the word *Wrap*. Then type *N* to change the option value from *Y* (Yes) to *N* (No) to stop wrapping altogether:

Text/Numbers	T	Insert on wrap	R	Margins: Top	0	File	No File	
Borders	Y	Calc: Auto/Man	A	Header	2	Page	1	Insert
Justify	N	Columns/Rows	C	Footer	2	Free	20480	
Wrap	Y	Decimal places	2	Bottom	8			
Page length	66	Minus/Brackets	M	Left	0	Title		
Line spacing	1	Lead chs.	£	Header				
Start page		Trail chs.	£	Footer				

Finally press the **ESC** key to return to the document.

## Setting up headings

Before entering information into PipeDream, it is good practice to set up headings to specify how the information will be arranged. Since you are going to create a name and address list, the headings will simply correspond to the name and address, with one reserved for additional information.

When you start a new sheet in PipeDream you are given six columns, each 12 characters wide. Although you can enter lines of text much wider than this in each column, it will make working with the name and address information simpler if, at this point, you make each of the columns in the document wider. You do this with the **Width** command in the **LAYOUT** menu.

Press the **[MENU]** key until the **LAYOUT** menu is displayed. The **Width** command may already be highlighted as it is the first item on the menu; otherwise use the cursor keys to highlight it. Then press **[ENTER]** to select it. In reply to the prompt

**New width**

**type**

24

and press **[ENTER]** to carry out the change. (You can ignore the other prompt – **Specify column**.)

The width of the column containing the cursor, column A, will increase to 24 characters.

Now move the cursor into column B by pressing the **[TAB]** key, and repeat the procedure to set the width of column B to 24 also. You can, if you wish, select the **Width** command directly without going through the **LAYOUT** menu, by typing **◇W**.

Continue until you have set each of the columns A to F to a width of 24 characters. Notice that when you press the **[TAB]** key to get from column C to column D, the document moves to the left on the screen so that columns D and E come into view without the cursor position changing.

Then move the cursor back to the left-hand side of column A by typing **◇[TAB]**.

Type the following headings, pressing the **[TAB]** key between each heading to move the cursor to the beginning of the next column.

Name [TAB]  
 Address [TAB]  
 Town [TAB]  
 County [TAB]  
 Postcode [TAB]  
 Info

Notice that when you type the word `Town` and press the [TAB] key, the document scrolls to the left so that the column headed 'D' comes clearly into view:

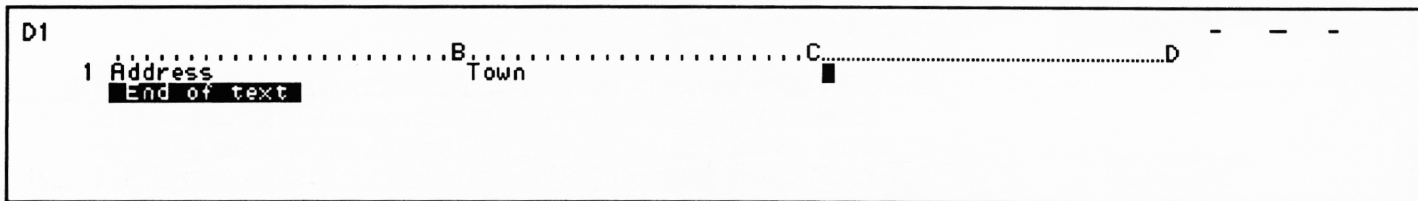

So, although you can only see three of the six columns in your document at any one time, it is a simple matter to move about and find the information you want.

Although it should be quite obvious what you will be using each of the first five headings for, you may be wondering what the purpose of the last heading `Info` might be. You can use this to record additional information about all of the people in your address list, such as whether you sent them a Christmas card last year, when their birthday is, or any other information you would like to be able to recall. In the following examples the field will contain the person's age.

## Entering some information

Move the cursor back to the left-hand side of column A by typing `◊[TAB]`. Press the [ENTER] key to move the cursor to row 2.

You can now type the first name into slot A2.

Bell, A

Press the [TAB] key when you have finished typing the name to move the cursor across to the address column, column B. Type in the address, remembering to press the [TAB] key between each item:



Bell, A [TAB]  
 2 Ringway [TAB]  
 Tring [TAB]  
 Herts [TAB]  
 TE1 2LM [TAB]  
 24

A3		A.....	B.....	C.....
	Name	Address	Town	County
1	Bell, A	2 Ringway	Tring	H
2				
3	End of text			

Enter the other names and addresses given below on lines 3, 4, 5, and 6 of your document in exactly the same way. Of course, if you prefer, you can compile your own list. If part of an address is too long to fit within one column, just keep typing; although you will not be able to see all the information in that column, it will be retained and you will be able to refer to it later.

Also, be sure to keep to the headings at the top of the document. For example, if a particular address does not have anything corresponding to a county, leave that column blank so that you put the postcode under the correct heading. This will enable you to search for a particular postcode, as described later.

Complete the table as follows:

Name	Address	Town	County	Postcode	Info
Bell, A	2 Ringway	Tring	Herts	TE1 2LM	24
Long, C	9 Knott Close	Farnham	Surrey	WAY 2G0	27
Rover, A	4 Chase Mews	Kenilworth	Warw.	K9 WUF	12
Bird, J	27 Wood Lane	Bath	Avon	CB1 L23	14
Hill, Max	10 Upper Street	Steep	Hants	UP 2IT	43

## Saving the document

Since by now you may have spent some time entering information into your document, it is a good idea to save a copy to the Z88 filing system in case you accidentally lose the information during the next experiments. You save a copy of the document by using the same procedure as the one used for the party invitation.

Select the **Save** command by pressing the **MENU** key until the **FILES** menu is displayed. Press the **↓** key to highlight **Save**. Then press **ENTER** to give the **Save** command.

Type addresses as the name of file to save, ignoring the other options since you want to save the whole document, and press **ENTER**. A copy of the document will now be saved to the filing system.

## Sorting the information

Now that you have entered a table of names and addresses, it would be useful to have them sorted into alphabetical order so that you can look up a particular name more easily.

First you need to specify which part of your document you want to sort. Move the cursor to slot A2, the top left-hand corner of the table of names and addresses, using the **↑** and **↓** keys to move up and down the document and the **TAB** and **SHIFT TAB** commands to move across the document between columns to the left and right.

Mark slot A2 by giving the **Mark Block** command from the **BLOCKS** menu, or by typing **◇Z**.

When you give the command, slot A2 will be highlighted on the screen to indicate that it has been marked:

	A.....	B.....	C.....	D.....	E.....	F.....
1	Name	Address	Town			
2	<b>Ball, H</b>	2 Ringway	Tring			
3	Long, C	9 Knott Close	Farnham			
4	Rover, A	4 Chase Mews	Kenilworth			
5	Bird, J	27 Wood Lane	Bath			
6	Hill, Max	10 Upper Street	Steep			

Now mark the bottom right-hand corner of the table of names and addresses. Move the cursor down to row 6 and across to column F with the **↓** key and the **TAB** command. Then give the **Mark Block** command again. When you have completed the second **Mark Block** command, the

entire table of names and addresses will be selected and shown highlighted on the screen.

F6

1	County	Postcode	Info
2	Herts	TET 2LN	24
3	Surrey	WAY 2GO	27
4	Warw.	K9 WUF	12
5	Avon	CB1 L23	14
6	Hants	UP 2IT	43

The highlighted table of slots is referred to as a 'block', and several commands are available which will operate on an entire block of slots that you have selected.

Move back to the left-hand side of the sheet with  $\diamond$  [TAB].

To sort the block of slots, use the **Sort** command from the **BLOCKS** menu. Press the [MENU] key until the **BLOCKS** menu is displayed. Then press the  $\downarrow$  key until the **Sort** command is highlighted on the menu, and press [ENTER] to select the command.

We wish to sort the names and addresses into alphabetical order of the names, which are in column A, so type A to the prompt

Sort on column A

and press the [ENTER] key to perform the sort. (You can ignore the other prompts for the moment.)

You will see that the names and addresses have been correctly sorted within the table. You can clear the marked block by giving the **Clear Mark** command from the **BLOCKS** menu, or by pressing  $\diamond$  Q:

A6

1	Name	Address	Town
2	Bell, A	2 Ringway	Tring
3	Bird, J	27 Wood Lane	Bath
4	Hill, Max	10 Upper Street	Steep
5	Long, C	9 Knott Close	Farnham
6	Lover, A	4 Chase Mews	Kenilworth

You could, of course, have sorted the information on a different heading by specifying another column, rather than column A, when you gave the **Sort** command. For example, you may like to experiment with sorting the same names and addresses on the Town column, or on the column containing the peoples' ages.

---

## Finding information

You could have entered many more names and addresses than the few you have already stored without running out of space in the document.

You can see how much space is available in a document at any time by typing `◇O` to display the Options Page. The number of characters of space available is given after the heading `Free` on the right-hand side of the Options Page display. Press `[ESC]` to return to your document.

In a large list of names and addresses, it would be very inconvenient to have to search around in the list for a particular name or address. Fortunately, there is a much faster way, using the automatic search facility built into PipeDream.

Select the **Search** command from the **BLOCKS** menu in the usual way: display the **BLOCKS** menu with the `[MENU]` key, and use the cursor keys to highlight **Search**; then press `[ENTER]` to give the **Search** command.

The **Search** command displays a number of options which allow you to specify exactly what you want to search for, and whether you want to restrict the search to a particular part of your table of information.

For example, you might want to search for the address of someone whose surname you had forgotten, but whose Christian name you knew to be Max. You would then enter `Max` against the first option:

```
String to search for           Max
```

Press `↓` to move to the next option which initially shows:

```
Search only range of columns   No
```

and press `Y` to alter the option value to `Yes`, and type `A`, to specify that you want to search only column A, which contains the names. The option will now read:

```
Search only range of columns   Yes A
```

Then press **ENTER** to begin the search. The cursor will instantly find the name **Hill, Max**, allowing you to read off his address.

Incidentally, if the name you chose to search for found someone else with the same name first, you could use the **Next Match** command on the **BLOCKS** Menu to move on and find the next item that contained the same name.

## Help with searching

It is a peculiarity of the way we remember information that we can often only remember part of what we are trying to recall. For example, we may know that the person we are trying to find lives in a town called something like Caxton – or perhaps it was Croxton? Or then again, perhaps it was Foxtton. The PipeDream **Search** command has two facilities which help in just this type of situation.

You can type the symbols **^#** in the string you are looking for, to represent any combination of letters (including none). Thus, you simply have to specify

**String to search for** **^#xton**

to find any of the towns, Caxton, Croxton or Foxtton, or any other town ending in 'xton'.

You can also specify the symbols **^?** which will match any single letter or character in the string you are searching for. So, if you could only remember that the name of a road had three letters, you could search for

**^?^?^?** Road

and you would be sure to find it.

## Printing information

To print out the information in your name and address list as an orderly table, select the **Print** option from the **PRINT** menu. Press the **MENU** key until the **PRINT** menu is displayed. Select **Print** using the cursor keys, and then press **ENTER** to give the command.

Since the total width of the table of names and addresses is 144 characters (six columns of 24 characters) it will probably be too wide to fit across the width of the paper on your printer; most printers will only

print 80 characters. You will therefore need to print the table in two sections, by selecting a range of columns in each case.

The first time you give the **Print** command, alter the option

```
Print only range of Columns          No
```

to **Yes** by typing Y, followed by A C so that the option reads

```
Print only range of columns          Yes  A C
```

Then press the **[ENTER]** key to start printing. Once this is finished, give the **Print** command again, this time specifying the option as

```
Print only range of columns          Yes  D F
```

Alternatively, some printers will print up to 132 characters across; in this case you may be able to fit the whole table onto a single sheet of paper by first reducing the width of some of the columns using the **Width** command on the **LAYOUT** menu.

## Printing selected rows

If you were going to use the name and address list for a business mail shot, you might want to compile a selective list containing only the names and addresses of people living in one particular area. The PipeDream **Print** command caters for this by allowing you to specify a test to be performed on each row of the document. Only those rows for which the test succeeds will be printed.

You specify the test in terms of slots in row 1; PipeDream automatically alters the slot coordinates to refer to the appropriate row as testing proceeds through the document.

For example, to print out the names and addresses of all the people living in Hants or Surrey, give the **Print** command in the usual way by displaying the **PRINT** menu and then pressing **[ENTER]** to give the **Print** command. Then move the cursor to the option

```
Select rows to print                  No
```

Change the option value to **Yes**, by typing Y, and type in the selection expression

```
D1="Hants" | D1="Surrey"
```

The '|' symbol means 'OR', so the whole expression means: "If the item in slot D1 is Hants or the item in slot D1 is Surrey...". In row 2 the test will apply to D2, and so on.

The selection expression can be virtually as complicated as you need, and can include tests on several different columns. For example, for a mail shot of information on a new wonder hair tonic you might want to select all men over 30 on the name and address list. The expression might be

```
D1="London" & G1="M" & F1>=30
```

where G1 was an extra column containing M or F to indicate the sex. The '&' symbol means 'AND' and can be used to link several tests together.

---

# Calculating home expenses

---

The next worked example shows how to use the Z88 to perform numerical calculations. It shows how you would analyse your monthly expenses, and discover what proportion of your income you were spending on each.

You will learn how to:

- Enter numbers and expressions into a table
- Copy expressions to save typing
- Perform calculations
- Alter the format of the numbers

---

## Designing the table







You are going to create a table which shows for each of the months January to May what your expenditure has been on your mortgage, food, car, gas and electricity, and telephone.

At first sight it might appear that an awful lot of typing would be involved in setting up such a table. However, as you will see, all the repetition is carried out automatically for you by PipeDream and very little typing is actually needed.

---

## Moving around the document

To set up the table of expenses you will need to be familiar with the procedure for moving the cursor between slots (or columns) in the document. Remember that you will need to use the following keys:

-  to move up a line
-  to move down a line
-   to move to the previous slot to the left
-  to move to the next slot to the right
-   to move to the leftmost slot



Also, when you are at the left-hand edge of a slot, pressing  $\leftarrow$  will move to the previous slot to the left, if there is one.

When you are working with a document you can use the **First Column**, **Last Column**, **Top of Column**, or **Bottom of Column** commands on the **CURSOR** menu to move to the four edges of the document in a single operation.

## Labelling the table

You are now going to set up the column and row labels for the table of expenses.

Move the cursor to slot B1 and type the label Jan (for January). Likewise type Feb, March, and April in slots C1 to E1 to complete the column headings for the table. Later you could extend the table for a whole year's figures.

Now type the row labels for the different expense categories, as follows:

In slot:	Enter:
A2	Rates
A3	Mortgage
A4	Food
A5	Car
A6	Gas/Elect

The table headings are now complete. Move the cursor back up to slot B2, and the table should appear as shown on the following screen:

B2	.....A.....B.....C.....D.....E.....↓F	┌-----┐		
1	Jan	Feb	March	April
2	Rates			
3	Mortgage			
4	Food			
5	Car			
6	Gas/Elect			

## Entering the rates

The rates in the example are going to be £500 per half-year. This is going to be divided evenly over each month's expenses, but you do not need to divide 500 by 6; PipeDream will do it for you. You only have to enter the expression 500/6 into slot B2 (the '/' sign means divide).

However, you first need to specify that this slot is to be an expression slot, so that whatever you type into it will be evaluated, and so that other slots on the table can refer to the result. To do this you give the **Edit Expression** command from the **EDIT** menu; alternatively you may find it more convenient to type  $\diamond X$  which has the same effect.

The slot B2 will be highlighted on the screen to show that you are editing an expression slot, and the cursor will move to the centre of the top line of the screen so that you can enter an expression. Type the expression

500/6

and press the **ENTER** key to enter it into slot B2. The number 83.33 will be displayed right-aligned in slot B2.

---

## Referring to slots

You do not need to type the rates expression into the other slots in row 2; you can simply indicate that you want the same value as slot B2 by typing the coordinates of that slot.

Move to slot C2 and press  $\diamond X$  to enter an expression. Then type

B2

and press **ENTER**. The value 83.33 will appear in slot C2. Likewise enter the expression B2 into slots D2 and E2.

Effectively you have specified that you always want slots C2 to E2 to contain the same value as slot B2. So, for example, suppose you were granted a rates reduction to £400 per half-year. Move the cursor back to slot B2 and type  $\diamond X$  to display the slot's previous contents, 500/6. Delete them, by typing

$\diamond D$

and then type the new value:

400/6

Not only will the value in B2 change to 66.67, but slots C2 to E2 will also change, since they refer to this value.

## Replicating values

Next you are going to enter the figure 200 for the four months' mortgage payments. Type 200 into slot B3. If you forgot to type  $\diamond X$  when entering the figure, the number will appear left-aligned just as you entered it. In this case, move the cursor back to the slot and press  $\diamond X$  and then  afterwards.

You do not need to type the same value in slots C3 to E3; the **Replicate** command will do it automatically.

Select the **Replicate** command from the **BLOCKS** menu, and press  to execute it. Answer the prompts as follows, pressing  $\downarrow$  to move to the next line after entering B3:

```
Range to copy from      B3
Range to copy to       C3 E3
```

This says that you are going to replicate the value in slot B3 to the range of slots C3 to E3. Press  to give the command, and the figure 200.00 should appear across the entire row so that the table appears as shown:

B3	A	B	C	D	E	F
1	.....	.....	.....	.....	.....	.....
2	Rates	Jan	66.67	Feb	66.67	March
3	Mortgage	█	200.00	200.00	200.00	April
4	Food					
5	Car					
6	Gas/Elect					

Note that until you press the  key you can alter the values you have typed for the ranges, moving between the two prompts with  $\uparrow$  and  $\downarrow$ .

## Other expenses

The expenses in the other categories will tend to vary each month. You can either type in the figures used in the example shown below, or use figures from your own experience. In either case complete the table, remembering to make each slot into an expression slot before you enter the figure, or if you forget, afterwards.

A1	A	B	C	D	E	F
	Jan	Feb	March	April		
1 Rates	66.67	66.67	66.67	66.67	66.67	
2 Mortgage	200.00	200.00	200.00	200.00	200.00	
3 Food	120.00	130.00	120.00	130.00	130.00	
4 Car	40.00	42.00	44.00	46.00	46.00	
5 Gas/Elect	100.00	120.00	110.00	112.00	112.00	

## Monthly totals

You are now going to produce monthly totals for the expenses. Enter the label TOTAL into slot A7, and press **TAB** to move the cursor to slot B7.

Now press **◇X**, and enter the following expression:

```
sum(B2 B6)
```

Press the **ENTER** key, and PipeDream will perform the calculation and instantly display the sum of the figures in the range of slots B2 to B6; ie all the expenses for January.

The function `sum(B2 B6)` is a convenient way of writing the equivalent expression

```
B2+B3+B4+B5+B6
```

where the slots to be added are all in a row, column, or rectangular table.

## Replicating slot references

Just as you replicated the value 200.00 above, you can also replicate an expression across a range of slots. Where the expression contains references to other slots, as in this example `sum(B2 B6)`, the references will automatically be altered to reflect the change in position.

Replicate the expression you have just entered for slot B7 to slots C7 to E7 as follows. Select the **Replicate** command from the **BLOCKS** menu, and give the options as:

```
Range to copy from      B7
Range to copy to       C7 E7
```

Press **ENTER** and totals will appear for each column. The **Replicate** command has automatically altered the range B2B6 to give the appropriate totals in columns C to E.

If you now move the cursor to slot C7 you will see the expression in that slot displayed at the top left-hand side of the screen:

```
sum(C2C6)
```

Note that PipeDream removes unnecessary spaces when storing an expression.

B7	sum(B2B6)	A	B	C	D	E	F
2	Rates		66.67	66.67	66.67	66.67	
3	Mortgage		200.00	200.00	200.00	200.00	
4	Food		120.00	130.00	120.00	130.00	
5	Car		40.00	42.00	44.00	46.00	
6	Gas/Elect		100.00	120.00	110.00	112.00	
7	TOTAL		526.67	558.67	540.67	554.67	

## Percentage expenditures

As a final illustration of the power of PipeDream in analysing figures, you are going to calculate the percentage expenditure represented by each of the categories in the table.

First type the label

Percentage

in slot F1.

Next find the total expenditure for the four months in the table. Move to slot F7, press **◇X**, and enter the expression

```
sum(B7 E7)
```

Instead of typing the references B7 and E7, you can 'point to' each slot by moving the highlighted slot with the keys **TAB**, **SHIFT TAB**, **←**, and **→**, and then give the **Insert Reference** command, **⇧K**, to enter the corresponding references, B7 and then E7, into the editing line.

Now move to F2 and enter the following expression (which will be explained in a moment):

```
sum(B2 E2)/$F$7 * 100
```

Press **ENTER** to enter the expression.

This expression is built up as follows:

sum(B2 E2) is the total spent on rates for the four months.

F7 is the overall total expenditure for the four months. The \$ signs 'freeze' the reference so that when the expression is replicated, the reference to F7 will remain the same.

sum(B2 E2)/\$F\$7 is thus the proportion of the overall expenditure spent on rates.

sum(B2 E2)/\$F\$7 \* 100 expresses this proportion as a percentage.

Now replicate this expression down the remaining slots in column F by giving the **Replicate** command from the **BLOCKS** menu, and entering the options as

```
Range to copy from      F2
Range to copy to        F3 F6
```

The appropriate percentages will be displayed against each category.

F2	sum(B2E2)/\$F\$7*100					
	A	B	C	D	E	F
	Jan	Feb	March	April	Percentage	
1						
2	Rates	66.67	66.67	66.67	66.67	12.23
3	Mortgage	200.00	200.00	200.00	200.00	36.69
4	Food	120.00	130.00	120.00	130.00	22.93
5	Car	40.00	42.00	44.00	46.00	7.89
6	Gas/Elect	100.00	120.00	110.00	112.00	20.27

## Changing the format

When you first start using PipeDream, the results of all expression slots are displayed with two decimal places, the most useful format for working with financial calculations (although values are stored internally with full accuracy).

You can alter the display format for all expression slots in your document by changing the *Decimal Places* option on the **Options Page** menu, or for individual slots with the **Decimal Places** command on the **LAYOUT** menu.

For example, the table would look tidier if the percentages were displayed with no decimal places. First, mark the block of slots containing the percentages with the following procedure:

- ① Move the cursor to F2 and give the **Mark Block** command on the **BLOCKS** menu; alternatively, type  $\diamond Z$  as shown on the list of key functions above the keyboard.
- ② Move the cursor to F6 and give the **Mark Block** command again.

The block containing slots F2 to F6 will now be highlighted.

Now select the **Decimal Places** command from the **LAYOUT** menu. Reply to the prompts as follows:

```
Number of decimal places      0
Floating format               No
```

Press **ENTER** and the numbers will be displayed with no decimal places.

You can also specify that certain characters, given on the **Options Page**, should be displayed before or after certain numbers in the document. By default, the trailing characters are set to '%', and the leading characters are set to '£'.

To display a '%' sign after the numbers in the marked block, give the **Trailing Characters** command from the **LAYOUT** menu.

You can also display a '£' sign before each value in the table. Mark the block of slots from B2 to E7 by moving the cursor to each of these slots in turn and typing  $\diamond Z$ . Then give the **Leading Characters** command from the **LAYOUT** menu.

Finally, the column labels can be right-aligned. Mark slots B1 to F1 with the **Mark Block** command,  $\diamond Z$ , and give the **Right Align** command from the **LAYOUT** menu.

Press  $\diamond Q$  to clear the marked area, and the table will now appear as shown:

F6 sum(B6E6)/\$F\$7*100						
	A	B	C	D	E	F
	Jan	Feb	March	April	Percentage	
1 Rates	£66.67	£66.67	£66.67	£66.67	12%	
2 Mortgage	£200.00	£200.00	£200.00	£200.00	37%	
3 Food	£120.00	£130.00	£120.00	£130.00	23%	
4 Car	£40.00	£42.00	£44.00	£46.00	8%	
5 Gas/Elect	£100.00	£120.00	£110.00	£112.00	20%	

## What you have learnt

These three examples have demonstrated how PipeDream can help you to write letters and design text documents (word processing), set up lists of information, sort them, retrieve the items you need (databases), and set up and perform calculations on tables of numerical or financial information (spreadsheets).

For simplicity, each example focussed on one aspect of PipeDream's capabilities. However, the real power of PipeDream comes in its ability to mix all three different functions in a single document. For example, the expense account could be incorporated into a letter to your bank manager, the name and address list could include financial information and calculations, or the party invitation could be automatically addressed to everyone on your name and address list.

You are now in a position to start using PipeDream for your own applications, but to get the most out of its facilities you will probably want to read through the list of commands given in Section Five. You will then be able to refer back to it when your requirements of PipeDream become more advanced.



---

## Section Three Using the Diary

---

This chapter will show how you can use the Z88 Diary application to organise your engagements, and plan your time. It demonstrates how to:

- Enter engagements into the Diary
- Search for and list out all engagements relating a particular thing
- Use the Diary with the Calendar popdown to find any date very quickly

---

### Entering the Diary

Before using the Diary, make sure you have set the correct time and date on the Clock popdown, as described in Section One.

You can enter the Diary in either of two equivalent ways, whichever you find most convenient:

*Either:* go into the Index, by pressing the **INDEX** key, and select the Diary from the APPLICATIONS list by pressing the **↑** and **↓** keys until the Diary item is highlighted. Then press the **ENTER** key to enter it.

*Or:* type **□D**. You can do this from anywhere, even another application.

Once you have made entries in the Diary, it will appear on the list of **SUSPENDED ACTIVITIES** in the Index, but there can only be one copy of the Diary.

Type **◇CT** to go to today's date, and the Diary screen display similar to the diagram shown below will appear:

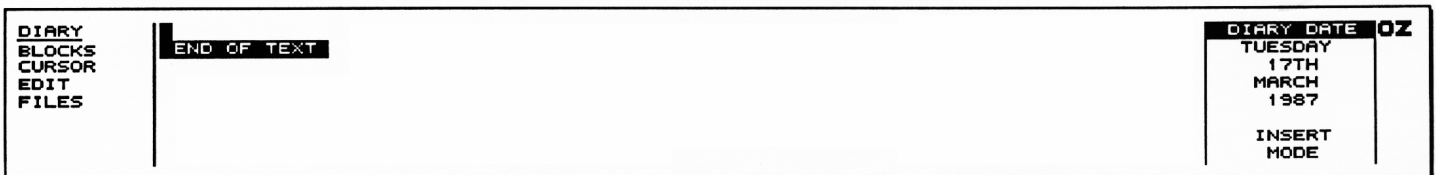

---

This gives you a page for today's date, onto which you can type information in any form you like. The information is stored permanently in the diary, and you will be able to refer back to it on another occasion.

---

### Making a Diary entry

Try typing the following appointments onto today's page in the Diary, pressing the **TAB** and **ENTER** keys where indicated to lay out the lines neatly:



Work: **TAB** 10.00 Sales meeting **ENTER**  
Simon: **TAB** 12.30 Pick up from station **ENTER**

You can actually lay out information in the Diary however you like, but it is a good idea to label your appointments, as in the example above, because you will then be able to locate everything in a particular category by searching for the appropriate label. An example of this is given below.

---

### Moving between days

You can move between days in the Diary by typing

-  to go to the next day
-  to go to the previous day

Try moving to the day after tomorrow, by typing   twice.

Then enter the following appointment:

Work: **TAB** 11.00 Present report to Board **ENTER**

## Searching for Diary entries

The Diary provides a powerful **Search** command which enables you to find and list out all appointments in a particular category.

As an illustration, the following example provides a list of all appointments relating to Work.

First select the **BLOCKS** menu, by pressing the **[MENU]** key until **BLOCKS** is highlighted on the menu bar at the left-hand side of the screen. Then move the cursor to highlight **Search** on the menu, and press **[ENTER]** to give the command.

The following prompts will be displayed:

```
----- STRING TO SEARCH FOR -----
EQUATE UPPER AND LOWER CASE ..... Yes
SEARCH ONLY MARKED BLOCK ..... No
PRODUCE LIST ..... No
PRINT LIST ..... No
```

Below the prompt **STRING TO SEARCH FOR** type

Work:

Then press **↓** three times to move the cursor to the line

```
PRODUCE LIST ..... No
```

and type **Y** to alter the value of the option to **Yes**.

Now press **[ENTER]**, since the other options are not relevant, and the appointments will be listed:

```
Thursday 17th March 1987
Work:  10.00 Sales meeting
```

```
Saturday 19th March 1987
Work:  11.00 Present report to board
```

Of course, in your case the dates will be different, corresponding to the information you have used.

## Using the Calendar and Diary together

By calling the Calendar popdown from within the Diary, you can move quickly between different dates, and the Diary will then give the page for the date you have selected.

For example, having forgotten a friend's birthday on the 17th March, you decide to make an entry in the Diary to make sure you do not forget it the following year. Use the following procedure to find the right day very quickly:

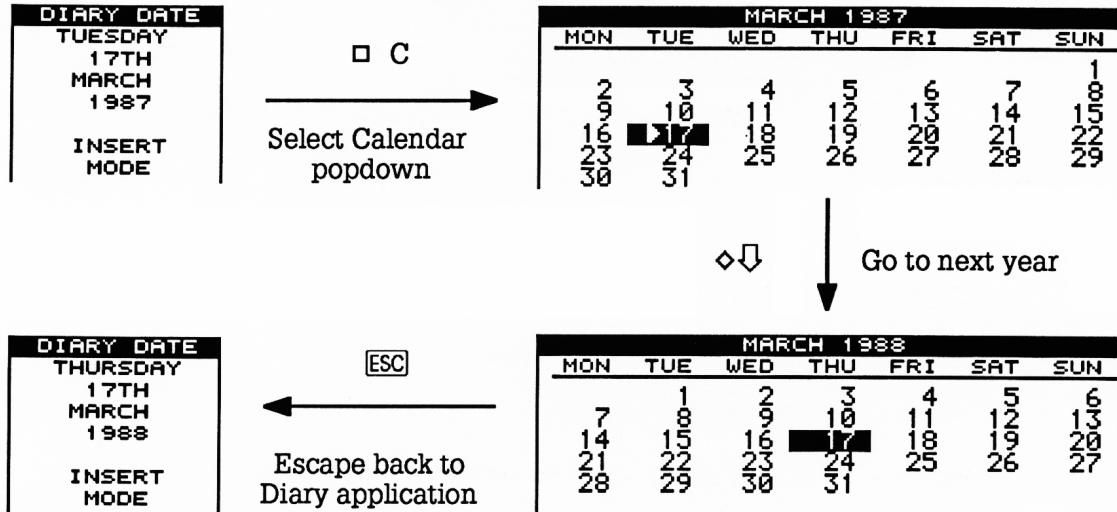

You are now on the diary page for the same date one year later, and can type in the reminder.

Refer to the following section for a full list of the Calendar operations.

---

## Section Four      Using the popdowns

---

The Z88 popdowns are utility programs that you can make use of while you are working within another application, such as PipeDream, the Diary, or BBC BASIC. They pop down over your application screen, and disappear again when you press **[ESC]** to return to the application.

The following popdowns are provided in the Z88:

<b>Calculator</b> - <b>□R</b>	Perform calculations
<b>Calendar</b> - <b>□C</b>	Look up dates
<b>Clock</b> - <b>□T</b>	See the current time, and today's date
<b>Alarm</b> - <b>□A</b>	Set alarms and reminders
<b>Filer</b> - <b>□F</b>	Perform operations with files
<b>Panel</b> - <b>□S</b>	Customise the Z88 to your requirements
<b>Import/Export</b> - <b>□X</b>	Transfer documents between the Z88 and other makes of computer
<b>Index</b> - <b>[INDEX]</b> or <b>□I</b>	Enter applications, popdowns, or suspended activities, and examine which cards are present

---

### Using popdowns

You can either call a popdown by pressing the **□** key combination given above, or from the Index as follows:

#### Calling a popdown from the Index

Highlight the popdown's name on the APPLICATIONS list. You can move the bar highlighting items on this menu by pressing the **↑** and **↓** keys at the bottom right of the keyboard. If you move the bar too far, press **↑** to go up again. Then press **[ENTER]** to run the popdown you have selected.

---

# The Calculator – OR

---

If you ever need to perform calculations while using the Z88 you can simply call up the Calculator popdown, even if you are in the middle of doing something else at the time:

CALCULATOR					CONVERT	
0.00					Gallons	<- Litres
Clear	DEL	StoM	RcIM	+	Miles	km
7	8	9	Unit	x	MPG	l/100km
4	5	6	Y<>X	-	Acres	Hectares
1	2	3	Sign	/	lb	kg
0	.	%	Fix	=	oz	g
					DegF	DegC



The top line of the calculator displays the result of your calculation – initially 0.00 – and below that are the calculator keys. You can press these in either of two ways, depending on your preference.

*Either:* Use the cursor keys  $\uparrow$   $\downarrow$   $\rightarrow$   $\leftarrow$  to highlight the operation you want, and then press **ENTER** to enter the selected key.

*Or:* Type the Z88 key corresponding to the key you want, as listed on the next page.

Calculator Key Legend:	Z88 Key Equivalent:	Function:
Clear	C	Clear
DEL		Delete last keypress
StoM	S	Store to memory 0 to 9
RclM	R	Recall from memory 0 to 9
0 to 9	0 to 9	Enter digit
.	.	Decimal point
Unit	U	Convert units (see below)
Y<>x	Y	Swap y and x
sIgn	I	Change sign
Fix	F	Number of decimal places
%	%	Percentage (see below)
+	+ or P	Plus
X	X, *, or T	Times
-	- or M	Minus
/	/, \, or D	Divide
=	=	Result

## Entering numbers

Enter a number by selecting the digits with the cursor keys, and press ; or just type the number with the keys 0-9. You can use C or  to correct typing mistakes. Numbers can contain a decimal point, obtained by typing the full-stop key, and can be entered in scientific notation, as in

1.27E6, entered as 1 . 2 7 E 6, which means  $1.27 \times 10^6$ .

7.1E-13, entered as 7 . 1 E I 1 3, which means  $7.1 \times 10^{-13}$ .

The two operands of an operation can be exchanged, before pressing =, by selecting the Y<>x operation, or pressing Y. For example, to find the reciprocal of a previous calculation, enter

/ 1 Y =

All calculations are performed to an accuracy of nine decimal places, and numbers can lie between  $1E38$  and  $1E-38$ . The Calculator displays **Error** if an error, such as  $1/0$ , occurs.

---

## Display format

The format in which numbers are displayed can be altered with the *Fix* operation, which gives the prompt

**Fix?**

Typing a number between 0 and 8 will fix the number of decimal places displayed to the specified number; the initial value is 2. Typing 9 will give free format.

---

## Constants

Entering a number, followed by one of the arithmetic keys pressed twice, stores the operation as a constant operation and displays the operator with K at the top right-hand corner of the screen.

For example, entering

1.15 \* \*

sets up constant multiplication by 1.15, and displays \* K; entering

1000 =

then gives the result 1150.00, and

2000 =

gives the result 2300.00.

---

## Storing and Recalling

You can store a result for use later in a calculation with the StoM and RclM operations.

To store a result, select the StoM operation (or type S). The prompt

**StoM ?**

will be given, to which you should give a register number by typing a digit from 0 to 9. Up to ten different results can be stored, one in each register.

You can also add a result into a register, subtract a result from a register, multiply a register by a result, or divide a register by a result,



---

by giving the StoM operation followed by '+', '-', '\*', or '/' respectively, followed by the register 0 to 9.

You can cancel a store operation in the middle by pressing **ESC**.

For example,

1.2 S 9

stores 1.2 in register 9, and

3.56 S-9

subtracts 3.56 from the same register. Finally

R 9

recalls the result from register 9.

---

## Percentages

The '%' key works in conjunction with one of the other keys '\*', '/', '+', or '-' to calculate percentages, and to add or subtract a given percentage to or from a number. The following examples illustrate each of these cases.

To find 12% of 1500 enter

1500 \* 12 %

To express 660/880 as a percentage, enter

660 / 880 %

To add 15% on to 125 enter

125 \* 15 % +

Likewise, to discount 125 by 15% enter

125 \* 15 % -

## Converting units

You can convert any result between the pairs of units displayed on the **CONVERT** menu by selecting the *Unit* operation.

Highlight the unit you want to convert to using the cursor keys, and press **[ENTER]** to perform the conversion. For example, to convert from Litres to Gallons highlight Gallons, and to convert from Gallons to Litres highlight Litres. To exit from the **CONVERT** menu press **[ESC]**.

---

# The Calendar – □C

---

The Calendar provides a convenient tool for planning your engagements, particularly when you want to look up dates quickly without leaving the application you are currently working on. Calling the Calendar displays the page for the current month, or the month you last looked at:

MARCH 1987						
MON	TUE	WED	THU	FRI	SAT	SUN
	2	3	4	5	6	7
8	9	10	11	12	13	14
15	16	17	18	19	20	21
22	23	24	25	26	27	28
29	30	31				

You use the cursor keys, in combination with the **SHIFT** and **◇** keys, to move about within the calendar as follows:

←	previous day	→	next day
↑	previous week	↓	next week
<b>SHIFT</b> ↑	previous month	<b>SHIFT</b> ↓	next month
◇ ↑	previous year	◇ ↓	next year

If necessary, the calendar will automatically turn a page to the next or previous month.

The Calendar is accurate back to the year 1753 (when the Gregorian calendar was accepted in England) and so has historical applications in addition to its obvious business uses.

## Searching for a day

You can also use the Calendar to go immediately to any date in any year.

Press `[ENTER]`, and the prompt

```
Look for: 17/03/1987
```

will be displayed, with today's date initially displayed. Type in the date you are searching for, and press the `[ENTER]` key. The cursor will move to the specified day.

The date can also be entered in the form

```
17 mar 1987
```

if you find this more convenient. The Z88 defaults to the twentieth century, so `17 mar 87` is equivalent to `17 mar 1987`.

---

## Active days

If the Calendar popdown is called from the Diary application, days containing information in the Diary will be identified on the Calendar with a pointer against the date

```
▶17
```

Such active days can be found in the Calendar very quickly with the commands

`□ ←`    previous active day        `□ →`    next active day

---

# The Clock – □T

---

The Clock popdown can be called whenever you need to see the correct time or date. The time is displayed in 24-hour format, and is accurate to within a few seconds per day. To set the time and date, see the details given in **Set the clock**, p. 9.



Press **[ESC]** to return to the current application.

Because you may be using the Clock popdown to time something, the Z88 will not switch off after the timeout period if the clock is displayed on the screen.

---

# The Alarm – □A

---

The Alarm popdown can be used to make your Z88 remind you of important events or appointments, or simply to wake you up in the morning. Any number of alarms can be set up, and for each alarm you can specify the following information:

## DATE

The date on which the first alarm will occur. For a new alarm this is initially set to the current date, or if the alarm is called from the Calendar or Diary, the Calendar or Diary date.

## TIME

The time at which the alarm will occur. For a new alarm this is set to the current time, but you will usually alter it to the required alarm time. All times in the Alarm are given in 24-hour format.

## REASON/COMMAND

For each alarm you can specify a message of up to 23 characters, or a CLI command string which will be executed to cause something to happen; see below.

To set an alarm, press `[ENTER]`. The alarms you have set up will become active as soon as you exit from the popdown by pressing `[ESC]`.

Note that the Z88 will not switch off automatically while the alarm popdown is on the screen.

---

## Alarm options

Each alarm can also have the following optional settings:

*Bell*: can be **ON** or **OFF**, determining whether the Z88 bleeper sounds when the alarm is activated.

*Alarm type*: normally **ALARM**. This can be altered to **EXECUTE** to allow a command, in the **REASON FOR ALARM** field, to be executed when the

alarm is activated. Thus you could, for example, cause the Diary to be entered and a line of text to be typed in automatically on an alarm:

```
#DICT Urgent message
```

For more information on executing commands, see **CLI files**, p. 179.

*Repeat every:* normally set to **NEVER**, so that an alarm will occur just once, at the specified time and date. The repeat rate can be altered to one of the following to obtain a repeating alarm:

**YEAR, MONTH, WEEK, DAY, HOUR, MINUTE, SECOND**

You can move between these options with **[SHIFT]** **↑** and **[SHIFT]** **↓**; pressing **↑** or **↓** then increases or decreases the number of the unit selected. You can thus specify every **3 HOURS**, for example.

*No. of times:* specifies the number of times that the alarm will be repeated before being cancelled. It is initially set to **NEVER**, so that the alarm will occur just once. It can be set to **FOREVER** by pressing **↓**, or a number from one upwards by pressing **↑**. Holding the **[SHIFT]** key down while pressing **↑** or **↓** will increase or decrease the number in tens, and **◇↑** and **◇↓** will change it in hundreds.

By setting these fields appropriately, you can obtain almost every possible alarm setting. For example, to cause an alarm to occur on the 3rd March, 3rd April, and 3rd May, at 12.00, set

<b>DATE</b>	3 Mar 1987	<b>REPEAT EVERY</b>	1 MONTH
<b>TIME</b>	12.00	<b>NO. OF TIMES</b>	3

*Note:* Do not set the alarm to repeat every second for ever. You will not be able to cancel it without doing a soft reset.

---

## Clearing alarms

To clear an alarm, select it with the cursor keys **↑** or **↓** on the list of alarms, select **CLEAR ALARM** with **←** and **→**, and press **[ENTER]**. With a repeating alarm this just clears the present alarm; use **CLEAR ALARM** twice to remove a repeating alarm completely.

If an alarm occurs while the Z88 is turned off, the alarm will sound and the Z88 will be turned on in **LOCK OUT** state to prevent accidental key-presses. To clear this state turn the Z88 off and then on again in the usual way, by pressing both **[SHIFT]** keys.

---

# The Filer – □F

---

With extension RAM and EPROM cards fitted, you will have the ability to store many documents in your Z88. The Filer provides everything you will need for organising these; in particular it allows you to:

- Obtain a list (*catalogue*) of all your files, or the files in the optional EPROM card (**Catalogue Files** and **Catalogue EPROM**).
- Move files to and from an EPROM, which provides permanent storage on a removable card in slot 3 of the Z88 (**Save to EPROM** and **Fetch from EPROM**).
- Change the names of files within the filing system (**Rename**).
- Make additional copies of files (**Copy**), or remove files completely (**Erase**).

Other commands, for more advanced use of the Filer, are explained in the Filer Reference section.

When you have finished using the Filer, press **[ESC]** to return to the original application.

## Hierarchical structure

The Z88 filing system is a *hierarchical* filing system. This means that you can group files together within 'directories'. This facility is akin to keeping similar documents in a folder within a filing cabinet, and is of great assistance in keeping a large number of files orderly. However, for simple use of the filing system you will not need to use these facilities; see the Filer Reference section for a full description.

*Note:* With Operating Systems up to and including 3.0 it is important that you only exit the Filer by pressing **[ESC]**. In particular, if you are using **Catalogue Files** (◇CF) or **Catalogue EPROM** (◇CE) and you exit the Filer in the middle of the operation by using **[INDEX]** or □ followed by a letter, then one of the files can become marked as 'IN USE', and you will not be able to access it without performing a soft reset.



## Entering the Filer

The Filer display consists of two windows; a COMMANDS window, and a DIRECTORY window:

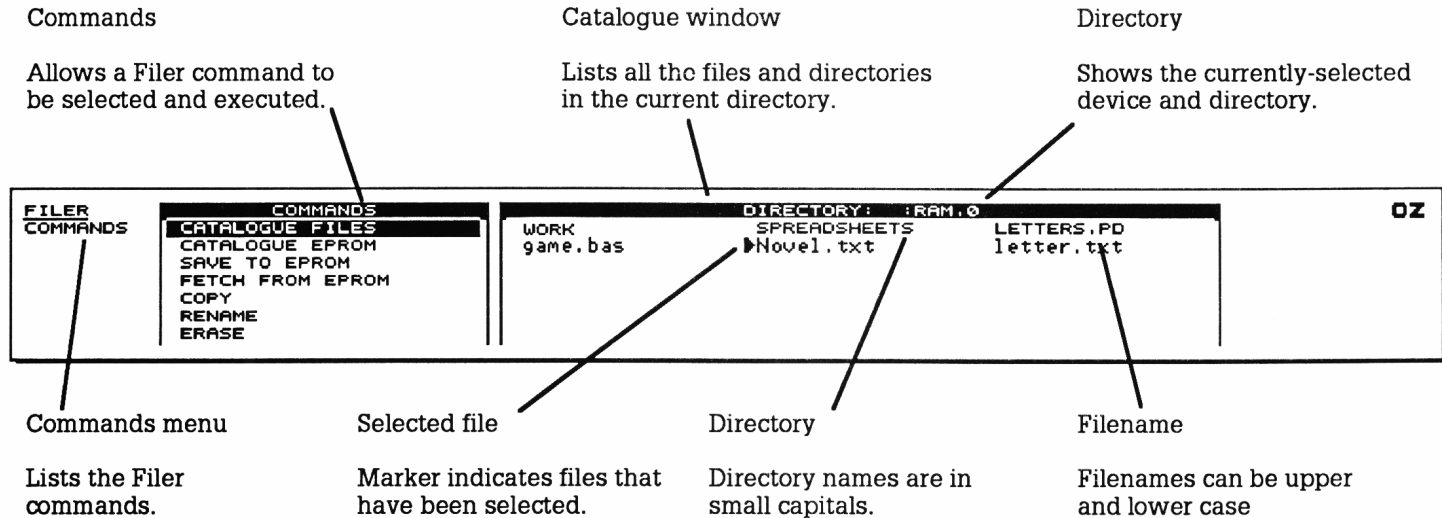

## File names

Each file or directory in the filing system has a name of up to twelve letters or digits. This can be followed by a full stop and up to three further letters or digits called the *extension*, and is normally used to describe the type of the file. Thus a BASIC program could be saved as

```
game.bas
```

where `bas` is an extension used for all BASIC programs.

Upper- and lower-case letters are treated as equivalent in file names. In the catalogue window directories are displayed in a small typeface.

## Specifying devices

When saving and loading files to and from applications, such as PipeDream, you will normally just give the file name and extension, if there is one. However, the Filer keeps a fuller description of where the file is in the system, including which RAM card it is on (the *device*), and several of the Filer commands will show this full form of the file name.

The full form of a file name is

*:DEVICE/filename*

The most useful options for *DEVICE* are:

:RAM.0                   RAM in slot 0 (internal memory)  
:RAM.1 to :RAM.3       RAM in slots 1 to 3 (external memory)

A full list is given in the Filer Reference section.

\* can be used in any part of a file name to match any characters; thus

game\*

represents any file name beginning with game, and

:RAM.\*

represents all the RAM in the Z88.

---

## Giving Filer commands

You can give filer commands in one of three ways, depending which you find most convenient:

- ① Select the command from the Filer **COMMANDS** list, using the  $\uparrow$  and  $\downarrow$  keys. The list of commands will scroll up if you move the cursor below the bottom of the screen. Then press **ENTER** to give the command.
- ② Select the command from the **COMMANDS** menu with the cursor keys, and press **ENTER** to give the command.
- ③ Give the  $\diamond$  key sequence for the command, as listed below.

## COMMANDS menu

Press **[MENU]** to see the **COMMANDS** menu:

<b>FILER COMMANDS</b>	Catalogue Files	◇CF	Create Directory	◇CD	Catalogue EPROM	◇CE	<b>[MENU]</b>	<b>OZ</b>
	Copy	◇CO	Select Directory	◇SI	Save to EPROM	◇ES	ADVANCE	
	Rename	◇RE	Up Directory	SHIFT ↑	Fetch from EPROM	◇EF	← → ↓ ↑	
	Erase	◇ER	Down Directory	SHIFT ↓	Select Device	◇SU	SELECT	
	Execute	◇EX	Cursor Right	→	Tree Copy	◇TC	<b>[ENTER]</b>	
	Select First File	<b>[ENTER]</b>	Cursor Left	←	Name Match	◇NM	ACTION	
	Select Extra File	SHIFT <b>[ENTER]</b>	Cursor Up	↑			<b>[ESC]</b>	
		Cursor Down	↓			RESUME		

## Selecting files

The Filer provides two ways of identifying the files you wish to operate on.

*Either:* Type the file name after the Filer prompt

Name : █

*Or:* Select the file or files in the catalogue window, as described below.

**Select First File** – **[ENTER]** or **[TAB]**

**Select Extra File** – **[SHIFT] [ENTER]** or **[TAB]**

Select the first file by highlighting the file name using the cursor keys, and press **[ENTER]** (or **[TAB]**). You can select further files, if required for an operation that can be performed on several files at once (eg **Erase**), using **[SHIFT] [ENTER]** (or **[TAB]** again).

When selected, files are indicated by a marker to the left of the file name in the catalogue window, as shown in the example on p. 81.

## Filer commands

The commands for simple use of the Filer are listed below; for full use of the hierarchical directory structure, see **Section Seven – Filer Reference**, p. 175

### Catalogue Files – $\diamond$ CF

Gives fuller information about a specified list of files. The subset of files to be catalogued is specified after the prompt

Name : ■

Reply as follows:

<b>ENTER</b>	catalogues all files (in the current directory)
fred*	catalogues all files beginning with fred
*.bas	catalogues all files with a bas extension

Each file will be listed as:

File name	Creation time and date	Last updated time and date	Size in characters
letter.txt	Today	17:42:54	1254
novel.txt	01-Jun-1987	17:41:17	13112
game.bas	02-Jun-1987	12:27:43	827

(The last updated time and date are only relevant if **OPENUP** is used from BASIC.) If the file is open at the time it is catalogued, the size will not be shown.

When you catalogue or save to a blank EPROM, the display will go blank for a few seconds while the EPROM is checked.

### Catalogue EPROM – $\diamond$ CE

Gives a list of information on all files in an EPROM card fitted in slot 3. The directories and file names will be given to show where the files originally came from.

### Save to EPROM – $\diamond$ ES

Copies files from the filing system to an EPROM card fitted in slot 3. The file or files to be saved can either be selected as already described, or specified after the prompt

Name : ■

Note that while a file is being saved to EPROM the screen will blank intermittently until saving is completed, when the Z88 will bleep.

### **Fetch from EPROM - ◊EF**

Copies files from EPROM card in slot 3 back to the filing system. Gives the prompts

```
Source :  
Destination :
```

*Source:* specifies the name of the file in the EPROM.

*Destination:* gives the name it is to be saved as in the destination filing system. It is initially set to the same as the source name, but you can edit it if you want to save the file under a different name.

### **Copy - ◊CO**

Makes a second copy of a file. Gives the prompt

```
Name :
```

allowing you to specify the file name to be copied, followed by the prompt

```
New name :
```

for the name of the copy.

Multiple files (selected in the catalogue window) can be merged into a single file with the **Copy** command; they will be appended in the order in which they were selected.

### **Rename - ◊RE**

Allows the name of a file to be altered. Gives the prompts

```
Name :  
New name :
```

For example, to change the name of a file from `game.bas` to `oldversion` you would specify

```
Name : game.bas
New name : oldversion
```

Note that you cannot use the **Rename** command to move a file from one directory or device to another. The new name must be a simple file name; devices and path names are not permitted.

### **Erase – ◇ER**

Allows one or more files to be removed from the filing system. Gives the prompt

**Name :**

followed by the prompt

```
Confirm each file ? Yes
```

Pressing **[ENTER]** will prompt for each file you have selected to be erased, so allowing you to change your decision for any particular file. Alternatively, changing the option to **No** by typing **N** will erase all the selected files without further prompting.

You will not be permitted to erase a file which is in use; for example, a directory containing other files, or an open BASIC file.

Files can only be erased from the EPROM with the ultra-violet EPROM eraser.

Note that because parts of an erased file may still be present, you should not rely on the **Erase** command for disposing of confidential information from the system.

### **Advanced Filer commands**

The remaining Filer commands are for advanced use of the Filer, and the hierarchical directory structure; these are explained in the **Section Seven – Filer Reference**, p. 175.

---

# The Panel – □S

---

The Panel popdown allows you to set up aspects of the Z88's operation to suit your own preferences. You can alter the rate at which keys on the keyboard auto-repeat when you hold them down, the time after which the Z88 will automatically switch off, the default device and directory used by the Filer, and the parameters for the serial interface.

You can call up the panel by typing □S (for Settings).

---

## Altering the panel

To alter an option on the panel, first select it by moving the cursor to the appropriate line with the cursor keys ↑, ↓, ⇨, and ⇩. Then type in the new value for the option, and press **ENTER**.

In the case of options with alternative values you can also select between the alternatives by giving the **Next Option** command, ⋄J, or you can specify the option you want by typing the option's first letter.

You can save a particular set of panel settings in a panel file, using the **Save** command on the **FILES** menu. Selecting the **New** command on the **FILES** menu returns the settings to their initial values.

---

## Panel options

For each of the following options the initial default value is shown in brackets.

Note that options marked † affect only the state of new activities, and existing activities retain their original settings.

### Keyboard options

*Auto-repeat rate (6)*: determines the rate at which keys auto-repeat when held down continuously. Smaller values increase the repeat rate. A value of 0 gives no auto-repeat.

*Keyclick (No)*: altering the option to **Y=Z** gives an audible bleep at each keypress, to provide additional feedback during touch-typing.

- † *Insert/Overtyping (Insert)*: in Insert mode text typed at the keyboard is inserted at the cursor position, and subsequent text on the line moves to the right to make space for the new text. Some typists prefer Overtyping mode, in which text types over any text previously on the line. To insert text in Overtyping mode you need to make a gap in the line with the **Insert Character** command  $\diamond U$  first.

### Filer options

- † *Default device (:RAM.0)*: the device to and from which files are saved and loaded, which is set to the internal RAM memory filing system by default. It can also be set to :RAM.1, :RAM.2, or :RAM.3, corresponding to the three RAM cards.
- † *Default directory*: allows a path of one or more directories, which should already exist, to be specified for all filing-system operations. By default the top-level directory is selected.

### Machine options

*Timeout (mins) (5)*: determines the time after which the Z88 will switch off if nothing is typed at the keyboard; a value of 0 disables timeout. Setting the timeout to 2 minutes will extend the effective battery life of the Z88 (1 minute is possible but not recommended for normal use).

*Sound (Yes)*: allows the internal sound system to be switched off.

*Map (Yes)*: allows the PipeDream page map display to be turned off if not required. Typing and editing will be marginally faster when the map is disabled.

*Map size (80)*: allows the size of the map to be altered up to a maximum size of 92 characters across, or 255 characters across on a Z88 with at least 128K in card slot 1. Reducing the size of the map allows a larger text display width to be used in PipeDream.

*Date format (European)*: determines the format for all dates in the Z88; the default date format is European, so that dates are recognised in the form:

day/month/year

The option can be changed to American to work with the format

month/day/year



---

**Serial port parameters**

*Transmit baud rate (9600) / Receive baud rate (9600)*: can both be set to any of the following values:

75, 300, 600, 1200, 2400, 9600, 19200, 38400

*Parity (None)*: can be set to None, Space, Mark, Odd, or Even. The number of data bits is 8 if None is specified, or 7 otherwise.

*Xon/Xoff (Yes)*: determines whether the serial communication protocol uses Xon/Xoff.

The number of start and stop bits is fixed as follows:

Transmit: 1 start bit, 2 stop bits.

Receive: 1 start bit, 1 stop bit.

*Note*: In versions of the Operating System up to and including 3.0 ODD and EVEN parity settings do not result in correct behaviour.

---

# Import/Export – □X

---

The Import/Export popdown enables you to transfer files between the Z88 and other makes of computer. It communicates with the other computer through the serial port on the right-hand side of the machine. To use Import/Export you will need an Import/Export program for the other computer, and a connecting lead. Follow the directions supplied with this for a detailed explanation.

Details of the serial port connections are given in Appendix B.

---

## Using Import/Export

The serial parameters should be set up in the Panel before running Import/Export. Also run the program on the machine you wish to communicate with.

The program recognises the following commands, which are given by typing the first letter of the command:

- |                       |  |
|-----------------------|--|
| <b>S)end file</b>     | Prompts for the name of the file to be transmitted, and then transmits the name and file to the receiving computer. Wildcards are accepted in the file name. |
| <b>R)ecieve file</b>  | Prompts for a file name; press <b>ENTER</b> to receive a file and use its transmitted name, or type a name to rename the received file.                      |
| <b>B)atch receive</b> | Receives a sequence of named files, terminated by an end batch code.   |
| <b>E)nd batch</b>     | Sends an end batch code (ESC Z).   |

To send a batch of files use the following procedure:

- ① Give the **Batch receive** command on the receiving computer
- ② Send each file with a **Send file** command (or give a '\*' wildcard in the file name)
- ③ Give an **End batch** command.

## Import/Export protocol

The Import/Export protocol is given here for programmers who want to interface the Z88 to a computer by writing their own interface software.

### Control sequences

Sequence	Function
ESC N	Start of file name
ESC F	Start of file/end of file name
ESC E	End of file
ESC Z	End of file or end of list of files
ESC B x x	Where x x is two ASCII digits representing a hex byte. For example, the byte &A9 is transmitted with ESC B A 9.
XON = &11	Receiver sends to transmitter to restart flow.
XOFF = &13	Receiver sends to transmitter to stop flow.

Note that all the characters after the ESC code must be in upper-case ASCII.

### Transfer protocol

First file, and subsequent files:

ESC N *filename* ESC F *data* ESC E

Last file:

ESC N *filename* ESC F *data* ESC Z

where *data* is a sequence of characters in the range &20 to &7E. Codes in the range &00 to &1F and &7F to &FF should be transmitted using the ESC B prefix.

Import/Export will give a **Suspended** message if a battery low is flagged while sending or receiving, or if the Z88 is switched off or the flap is opened. In this case you must repeat the transfer.

The *filename* can be omitted.

---

# The Index – □I

---

The Index popdown allows you to

- Enter popdowns or applications.
- Start PipeDream (or BBC BASIC) with a new, blank, document (or program).
- Obtain a list of all the suspended activities you have in the Z88, and remove activities you no longer need.
- Insert and remove RAM, ROM, or EPROM cards.

---

## The Index screen

### APPLICATIONS

Allows you to select and enter an application or popdown.

### YOUR REF.

Name given to identify a suspended activity

### SUSPENDED ACTIVITIES

Lists the activities being kept in the machine.

### CARDS

Indicates activities using an application card, and the associated slot number

INDEX COMMANDS	APPLICATIONS		SUSPENDED ACTIVITIES				OZ
	NAME	KEY	YOUR REF.	APPLICATION	---WHEN SUSPENDED---	CARD#	
	Diary	DD		Diary	Today	12:27:01	
	PipeDream	DP	Report	PipeDream	Yesterday	10:13:35	
	BASIC	DB	Epson	PrinterEd	Yesterday	09:06:10	
	Calculator	DK		COMM88	Yesterday	08:56:19	2
	Calendar	DC					
	Clock	DT					

## Entering an application

To enter an application, or a popdown, select its name on the APPLICATIONS list by moving the highlighting bar up and down with the cursor keys  $\uparrow$  and  $\downarrow$ , and press the **[ENTER]** key:

```
Diary           □D
PipeDream       □P
BASIC           □B
Calculator       □R
Calendar        □C
Clock           □T
Alarm           □A
Filer           □F
PrinterEd       □E
Panel           □S
Terminal        □V
Imp-Export      □X
```

When the bar reaches the bottom of the screen, the list scrolls up to show the remaining options.

Entering PipeDream (or BBC BASIC) from the Index APPLICATIONS list creates a new, blank document (or program).

---

## Suspended activities

The SUSPENDED ACTIVITIES list shows the following information for each suspended activity:

Heading	Meaning
YOUR REF .	The name given to the document (with the PipeDream $\diamond$ FC or $\diamond$ FL commands, the Diary or PrinterEd $\diamond$ FC, $\diamond$ FS, or $\diamond$ FL commands, or the BASIC *NAME command)
APPLICATION	The application name
WHEN SUSPENDED	The time and date the document was suspended
CARDS	The number of the card slot, for activities using an application card

There can be more than one PipeDream and BBC BASIC suspended activity, but only one for each of the other applications.

### Re-entering a suspended activity

To re-enter a suspended activity, select it by moving the highlighting bar across with the cursor keys, and then press the **ENTER** key. Alternatively, pressing **□P** or **□B** repeatedly will enter each PipeDream or BBC BASIC activity in turn.

### Killing activities – **◇KILL**

To kill a suspended activity, select it on the **SUSPENDED ACTIVITIES** list with the cursor, and type **◇KILL**. The activity will be removed from the list, and the document (or program) associated with it will be lost. **◇PURGE** is equivalent to a soft reset, which kills all suspended activities, and should therefore be used with great caution.

---

## Cards

There are three types of card for use with the Z88:

**RAM** cards are for storing your own information.

**Application cards**, referred to as ROM cards, are used for plug-in programs and help text.

**EPROM** cards allow you to write information once only, but retain it even when removed from the machine thus providing a secure way of saving your data.

### Card information – **◇CARD**

The **◇CARD** command, on the Index **COMMANDS** menu, shows the type and size of the card in each slot.

### Inserting or removing cards

Cards should only be inserted or removed with the Z88 switched on.

First enter the Index. Then open the perspex flap at the front of the machine. Check that the screen goes blank. The computer should bleep once as you open the flap. The card can then be pushed in or pulled out. The label on the end of the card should be upright when you push the card home. When you have completed the operation, push the perspex flap back into position.

### Card errors

Errors which occur during the insertion or removal of cards are displayed in the **OZ** position at the left-hand side of the screen.

A **FAIL** message is given if a RAM card is removed, indicating that a soft reset is necessary.

If you remove an application card which a suspended activity is using, the Z88 will give a continuous tone and flash **CARD** until the card is replaced. The suspended activity should be removed with **◇KILL** before trying again.

An **INDEX** message is given, together with a continuous tone, if you have attempted to remove an application card while not in the Index.

---

### RAM cards

RAM cards allow you to store more data in the Z88. RAM cards are available in different sizes; the 32K RAM approximately doubles the storage of the Z88, providing space for an extra 32,000 characters. The 128K RAM increases memory even more, allowing you to use the Z88 to store very large documents, diaries, or programs.

It is recommended that you avoid using slot 3 for RAM cards because they draw more current in slot 3 than in slots 1 and 2, and slot 3 would then not be available for EPROM cards.

#### Expansion facilities

Some additional facilities will be available on a Z88 which has a RAM card of at least 128K in slot 1:

Less than 128K in slot 1	128K or more in slot 1
Map limited to 92 pixels	Map can be up to 255 pixels
BASIC workspace 8K	BASIC workspace 40K

#### RAM card FAIL

If you do accidentally remove a RAM card, a **FAIL** message will appear and a soft reset will be necessary. The Z88 will attempt to keep all the files in the remaining RAM. If you need to change a RAM card you must therefore save all your important data into another RAM card, EPROM,

or transfer your files to another computer using the Import/Export programs.

Since the RAM cards draw their power from the Z88, the contents will be lost if the Z88 loses its power.

### **Using the Filer with extra RAM**

Files are normally stored in the internal memory. To make the Z88 use the external card you need to set the DEVICE to :RAM.n where n is the slot number (shown in white letters on the flap). The device used by new applications is determined by the Panel setting.

For example, if you have a RAM card in slot 1, set the Panel:

```
Default Device :RAM.1
```

Each existing application will store the device it is using. To alter these, first go into the application, and then use the **Select Device** in the Filer to change the device setting for each application you want to use the new RAM card.

---

## **EPROM cards**

EPROM cards can be inserted or removed at any time, except when you are actually reading or writing to EPROM. The EPROM card must go into the right-hand slot, labelled 3.

When you catalogue or save to a blank EPROM, the display will go blank for a few seconds while the EPROM is checked.

EPROM cards provide the best method of archiving valuable data files or programs. Once the EPROM is full, the recommended way to erase it (if required) is to use the ultra-violet EPROM ERASER from Cambridge Computer Ltd.

Note that an EPROM card should be removed before restoring power to a Z88 in any of the following circumstances, or data may be corrupted: after it has been left unpowered; after it has been left for some weeks so that the batteries have failed; after a persistent battery low sign; or when changing the batteries.

Never leave EPROM cards where sunlight can shine onto the round window. Significant exposure to strong direct sunlight of more than ten minutes may cause loss of data.



## **EPROM eraser**

The EPROM eraser will erase *all* the data stored in the EPROM by exposing the integrated circuit through the round window in the card to ultra-violet light.

### **WARNING**

If the internal light can be seen when there is no card present the EPROM eraser is faulty and should be returned.

The EPROM eraser produces an intense ultra-violet light which can only be activated by inserting a Z88 memory card into the eraser; this safety feature prevents any escape of ultra-violet light.

**REMOVE FROM MAINS SUPPLY WHEN NOT IN USE.**

Never touch the ultra-violet light source. It gets hot in use and may cause burns; also it is made of quartz and will cloud over due to moisture from the skin.

### **To erase an EPROM**

- ① Connect the eraser to the domestic mains supply. The plug should be fitted with either a 1 Amp or a 3 Amp fuse.
- ② Fully insert the EPROM card into the slot on the front of the eraser, with the round hole uppermost. The card is correctly inserted if the white label on the end of the card is visible and the printing "32K EPROM" or "128K EPROM" is upside down.
- ③ The action of inserting the card switches the eraser on. The yellow indicator light on top of the eraser should light and the EPROM will be exposed to ultra-violet light for approximately twenty minutes. After this time the ultra-violet light is automatically switched off and the yellow light will go out.
- ④ After the yellow light goes out, you can remove the card from the eraser. **DO NOT REMOVE THE EPROM BEFORE THE YELLOW LIGHT IS OUT.** The EPROM card should now be blank and ready for re-use. Removing the card resets the timer, so to erase another card, simply insert it; the yellow indicator light will again be illuminated, and the process can be repeated.

The ultra-violet light source decreases in efficiency with use and eventually a single 20-minute exposure may not completely erase all the data in the EPROM. In this case it may be a good idea to repeat the process a second time to be absolutely sure that it is thoroughly erased.

There is no means of erasing selected individual parts of data from the EPROM. When the EPROM is exposed to the ultra-violet source all data is affected in the same way.

---

## Application cards

Application cards, containing help text, an application, or both, can be inserted into any of the three slots. Note that you must first go to the Index before opening the card flap and inserting the card. When you close the perspex flap, the Z88 should register the new card.

Before removing an Application card, activities using the card must be killed. To do this, enter the Index, and examine the **SUSPENDED ACTIVITIES** window to see if the number of the card you want to remove appears in the **CARDS** column. Any activity with the Application slot number next to it is using the card, and should be killed with the **◇KILL** command. The card can then be removed.

Following a **CARD** message, you must replace the card in the same slot and then **◇KILL** any applications which are using the card. Following an **INDEX** message, you must return the card to its original slot and close the flap. You must then enter the Index and remove the card in the usual way.

---

# REFERENCE

<b>Section Five – PipeDream reference</b>	<b>103</b>
Setting the options	103
<b>Operations on blocks of slots – BLOCKS</b>	<b>104</b>
Marking	104
Replicating slots	105
Copy, Move, and Delete	108
Sorting	108
Searching and replacing	109
Other block operations	113
<b>Moving about the document – CURSOR</b>	<b>114</b>
Moving anywhere	114
Moving within a line/slot	115
Moving within a column	116
Moving between columns	116
Summary of PipeDream cursor operations	117
<b>Editing text and expressions – EDIT</b>	<b>118</b>
Editing within a line/slot	119
Editing within a column	120
Editing a document	121
Editing expression slots	123
<b>Working with files – FILES</b>	<b>125</b>
File names	125
Loading a document	126
Saving a document	127
Multi-file documents	128
<b>Altering the document layout – LAYOUT</b>	<b>131</b>
Column widths and margins	131
Widths and margins in a multi-column document	132
Alignment	134
Fixing rows and columns	135
Number formats	136

---

<b>Document options – OPTIONS</b>	<b>138</b>
Information lines	138
Option lines	139
Text format	140
Recalculation mode	141
Number formats	141
Page format	142
Headers, footers, and margins	142
Margins	144
<b>Printing documents – PRINT</b>	<b>146</b>
Highlighting text	148
<b>Expression slots</b>	<b>150</b>
Expressions	150
Operators	152
Functions	153
@ Fields	158
<b>Section Six – The Diary reference</b>	<b>161</b>
<b>Operations on a block of text – BLOCKS</b>	<b>162</b>
Searching and replacing	163
<b>Moving around the Diary – CURSOR</b>	<b>166</b>
Moving within a line	167
Moving within a day	167
Moving between days	168
Active days	168
Summary of Diary cursor operations	169
<b>Editing the Diary – EDIT</b>	<b>170</b>
Editing within a line	170
Editing within a day	171
Miscellaneous	171
<b>Loading and saving – FILES</b>	<b>172</b>
<b>Section Seven – Filer reference</b>	<b>175</b>
Specifying file names in full	175
Additional Filer commands	177
CLI files	179

---

<b>Section Eight – The Terminal</b>	<b>185</b>
Control keys	185
Spooling files	186
Transmitting files	186
<b>Section Nine – The Printer Editor</b>	<b>187</b>
Editing the driver definition	188
Highlight codes	188
Printer options	191
PrinterEd FILES menu	193
<b>Section Ten – BBC BASIC</b>	<b>195</b>
Entering BBC BASIC	196
Entering keywords	197
Editing BASIC programs	197
<b>BASIC keywords</b>	<b>199</b>
Special Z88 information	222
<b>BASIC operators</b>	<b>223</b>
Order of precedence	225



---

## Section Five

# PipeDream reference

---

This section describes all of the PipeDream commands that are available in each menu. To understand this chapter, you should already be familiar with the basic concepts of using PipeDream described in **Section Two – Using PipeDream**.

All commands can be typed directly from the keyboard, as well as chosen from the appropriate menu. The keyboard equivalent for each command is shown to the right of the command name in the menu. For example, the **Replicate** command on the **BLOCKS** menu appears as

**Replicate**      ◊BRE

This means that you can give the **Replicate** command by typing the ◊ key followed by the keys B R E. Note that the letters do not need to be in capitals: ◊bre has the same effect. Also, you can hold down the ◊ key while typing the letter keys if you prefer.

When, as in this example, the command equivalent is a sequence of two or three letters, the first letter will usually be the first letter of the menu name. For frequently-used commands, the key equivalent is a single letter with the ◊ key (in a very few cases the □ key). For example, the **Mark Block** command on the **BLOCKS** menu has the equivalent ◊Z.

Note that in the following screen diagrams the highlighting bar has been omitted for clarity.

---

### Setting the options

Some commands present you with a table of options which allow you to set up the command to your requirements.

To begin with, the cursor is positioned next to the first option; the cursor keys can be used as normal to move up and down the list.

Many of the options have only two possible alternatives: **Yes** and **No**. You can change the value shown either by typing Y or N as appropriate, or by using the **Next Option** command, ◊J, which alternates between the available values. In the case of options which take specific values, such as **Page Length**, **Next Option** restores the default value.

---

# Operations on blocks of slots – BLOCKS

---

PIPEDREAM	Mark Block	◊Z	Search	◊BSE	Word Count	◊BWC	MENU	OZ
<b>BLOCKS</b>	Clear Mark	◊Q	Replace	◊BRP	New	◊BNEW	ADVANCE	
CURSOR	Copy	◊BC	Next Match	◊BNM	Recalculate	◊A	↔ ↔ ↔ ↔	
EDIT	Move	◊BM					SELECT	
FILES	Delete	◊BD					ENTER	
LAYOUT	Sort	◊BSO					ACTION	
OPTIONS	Replicate	◊BRE					ESC	
PRINT							RESUME	

The commands on the **BLOCKS** menu enable you to manipulate documents to control exactly which areas are affected by a particular operation. A block can include anything from a single slot to a complete document.

---

## Marking

Before giving any block command you identify the slots you wish to operate on using the **Mark Block** command. You can mark a single slot, a row of slots, a column of slots, or a rectangular block of slots spanning several rows and columns.

You identify which block of slots you want to operate on by giving the **Mark Block** command at the top left-hand corner and bottom right-hand corner of the block. After giving the two **Mark Block** commands, all the selected slots in the block will be shown highlighted on the screen.

### Mark Block – ◊Z

Marks a single slot, or the top left-hand corner and bottom right-hand corner of a rectangular block of slots, to identify the slots to be operated on by subsequent block commands.

### Clear Marks – ◊Q

Clears any marked block previously set up with the **Mark Block** command.



## Replicating slots

### Replicate – ◇BRE

Reproduces the contents of a slot, or block of slots, in any part of the document. The following options are displayed:

```
Range to copy from
Range to copy to
```

Each range is a block of slots identified by specifying the coordinates of its top left-hand corner and bottom right-hand corner. If necessary, extra rows and/or columns are created in the document to accommodate the new slots.

The ranges can be one of the following forms:

#### 1. Single slot to area

*Range to copy from:* a single slot, eg A1.

*Range to copy to:* an area, eg B3 D7, or just a row or column range. The area can include the original slot, if required.

The contents of the slot are copied over the entire area, as represented symbolically in the following diagram:

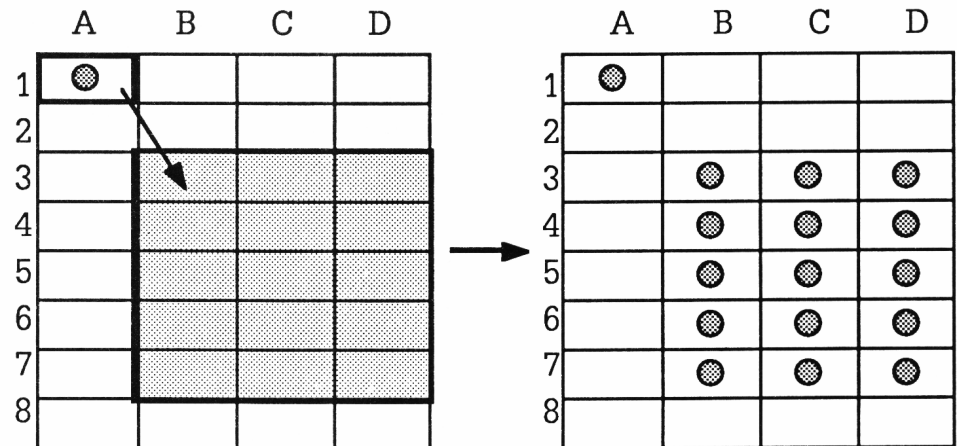

## 2. Column to area

*Range to copy from:* a column array, eg A1 A3.

*Range to copy to:* a single slot or a row array, eg B5 D5.

The column is copied to the target column starting at either the single slot, or the range of slots given by the target row.

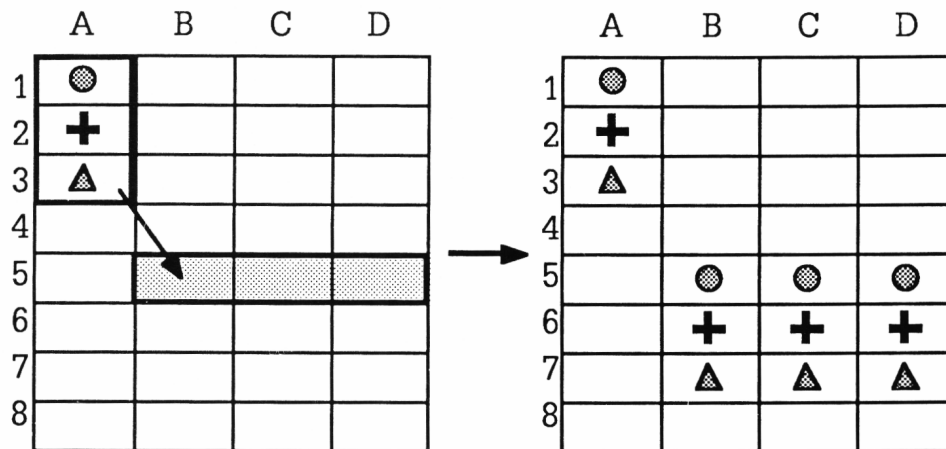

## 3. Row to area

*Range to copy from:* a row array, eg A1C1.

*Range to copy to:* a single slot or a column array, eg B5 B7.

The row is copied to the target row, starting either at the single slot or at the range of slots given by the target column, as shown on the following page:

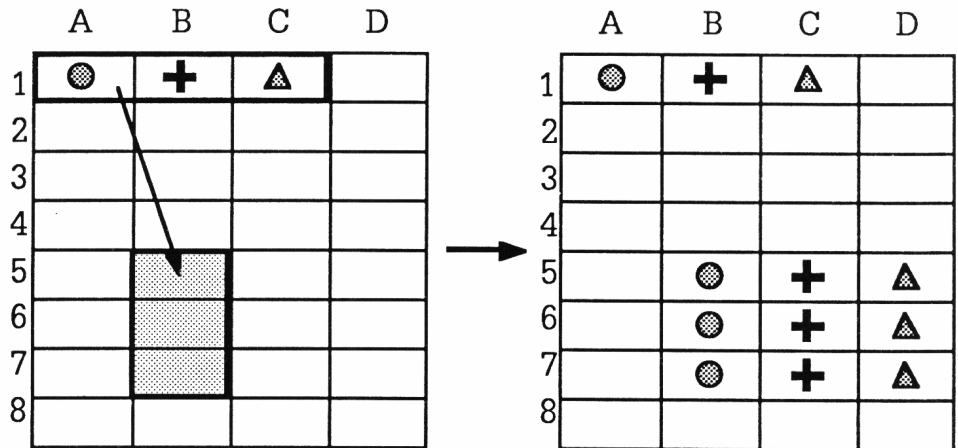

**4. Area to area**

*Range to copy from:* an area, eg A1 B2.

*Range to copy to:* a single slot, eg C5.

The area is copied to the area with the top left-hand corner defined by the single slot.

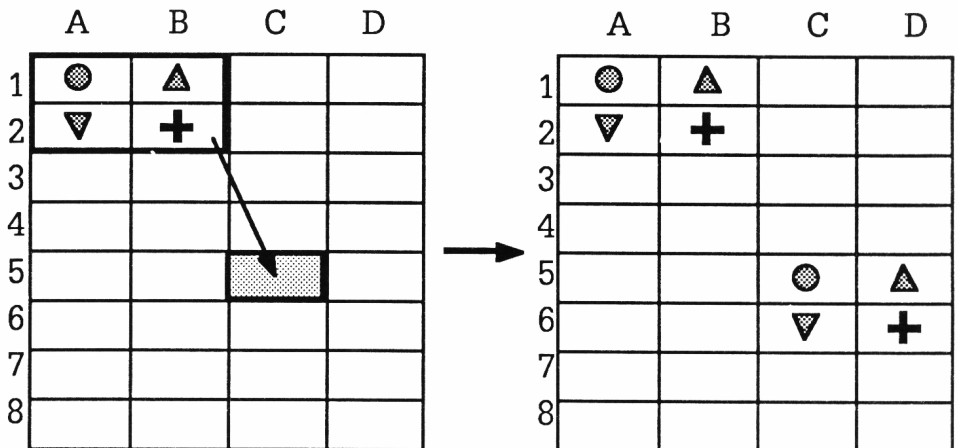

If the slots contain slot references, the references are updated to take account of their altered position, unless they are fixed with the \$ operator.

## Copy, Move, and Delete

### Copy – ⬠BC

Copies a marked block of slots to the position in the document indicated by the cursor. Slots in the document will be moved apart to make space for the block being copied, in contrast with the **Replicate** command which overwrites the target area.

Slot references in the new block are updated as for the **Replicate** command, but references to slots within the block are not altered.

### Move – ⬠BM

Moves a marked block of slots from its original position to the position indicated by the cursor. All slot references are updated as appropriate.

Note that if you attempt to move a block of slots to a new position which overlaps the same rows or columns as the original block, the error

`Overlap`

will be displayed.

### Delete – ⬠BD

Deletes a marked block of slots from the document. Since you will lose the information previously in those slots, it is a good idea to save a copy of your document before deleting a large area, so that you can revert to this if you accidentally delete valuable information.

---

## Sorting

### Sort – ⬠BSO

Sorts a marked block of slots. Text slots are sorted into alphabetical order, expression slots into numeric order, and date slots into date order. The following options are displayed:

```
Sort on column
Sort in reverse order           No
Don't update references         No
```

*Sort on column*: set to a column label (A, B, C etc) to specify which column within the marked block should be used to determine the ordering of the slots.

*Sort in reverse order:* by default, the marked block is sorted into ascending order, and any slot references are updated as appropriate. Setting this option to **Yes** will sort the specified column in descending order.

*Don't update references:* setting this option to **Yes** inhibits the updating of slot references within the block being sorted. This gives a faster sort operation, and can be used provided no slots within the sorted block are referred to either from within or from outside the sorted block.

## Searching and replacing

### Search – ⌘BSE

Search is for a specified string within a single document, or a multi-file document. The following options are available:

String to search for	
Search only range of columns	No
Equate upper and lower case	Yes
Search only marked block	No
Search from current file	No
Search all files in list	No

The string to be searched for is specified in the same way as for the **Replace** command, and the equivalent options have the same effect; see below.

When the search is completed, a message such as

```
27 found
```

will be displayed where 27 is the number of matches since the last **Search** command.

### Next Match – ⌘BNM

Following a **Search** command, the **Next match** command can be used to find the next occurrence of the specified string starting at the current cursor position.

### Replace – ⌘BRP

Searches for and replaces occurrences of one specified string by another. The following options are displayed:

```
String to search for
Replace with
Search only range of columns      No
Equate upper and lower case      Yes
Ask for confirmation              Yes
Search only marked block          No
Search all files in list          No
```

By default, the **Replace** command replaces all occurrences of the first specified string with the second specified string throughout the current document, equating upper- and lower-case letters and prompting for confirmation before each replacement. For example

```
String to search for      Cat
Replace with              Dog
```

will replace Cat with Dog, cat with dog, and CAT with DOG.

On each occurrence of the search string, the prompt

```
Replace: N, Y?
```

will be displayed at the top of the screen. Answer Y to perform the replacement, N to proceed to the next occurrence of the search string, or press the **[ESC]** key to cancel the command. When the command is completed, the message

```
27 found
```

(or as appropriate) will be displayed to show the total number of replacements that have been made.

*String to search for:* specifies the search string, which can be up to 240 characters in length.

Certain special sequences of characters can be used in the search string to represent characters which cannot be typed at the keyboard, or classes of search string:

Sequence	Matches
^1..^8	Highlight character
^^	^
^?	A single character – not space
^#	Any number of non-space characters (ie a word)
^S	A space
^Rref	Slot reference ref
^R#	Any slot reference
space	One or more spaces, or across slots
^B	Beginning of a slot (or line)

*Replace with:* specifies the string to replace each occurrence of the search string. The following special sequences of characters can be used:

Sequence	Substitutes
^1..^8	Highlight character
^^	^
^?n	Character matching nth ^? in search
^#n	String matching nth ^# in search
^S	A space
^Rref	Slot reference ref
^R#n	Slot reference matching nth ^R#
space	Matching spaces or slot boundary

Up to nine ^? fields, nine ^# fields and nine ^R# fields, numbered 1 to 9, can be used in the same replace string.

The ^# wild field will match zero characters, as long as the string which has been searched for contains at least one character (otherwise the wild field would match all spaces).

### Search and Replace examples

The sequences ^1 to ^8 represent highlight codes 1 to 8. For example, all occurrences of PipeDream could be put into bold with the options

```
String to search for      PipeDream
Replace with              ^2PipeDream^2
```

The sequence ^B forces the search string to start at the beginning of a line. For example, all single spaces could be removed from the beginnings of lines with the options

String to search for                    `^B^S`  
 Replace with

The sequence `^#` will match a sequence of characters not containing a space; ie a word, or a number. For example, to strip line numbers from spooled BASIC programs:

String to search for                    `^B ^#`  
 Replace with                            `^S`

Where `^#` or `^?` have been used to search for any words or characters, the words or characters that were found can be inserted in the *Replace with* string using `^#1` to `^#9`, or `^?1` to `^?9` respectively. For example,

String to search for                    `c^?r^?`  
 Replace with                            `^?2^?1ck`

will change `cart` to `tack` and `cord` to `dock`.

The sequence `^Rref` and `^R#` respectively match a specific slot reference, and any slot reference, in an expression slot. Thus,

String to search for                    `^R#`  
 Replace with                            `^R#1+1`

will replace all slot reference `A1` by `A1+1`, and so on.

*Search only range of columns:* enables you to specify a column range by entering a pair of column labels separated by a space: eg `A G`. The command is then restricted to the specified range of columns, inclusive.

*Equate upper and lower case:* by default, upper- and lower-case letters are treated as equivalent in the search string and the cases of letters in the replace string are altered to match the cases of the letters in corresponding positions of the matched string. Setting this option to `No` forces matches to be identical case. This means that, for example, specifying `Dog` to replace `cat` will have no effect on `cat` or `CAT`.

*Ask for confirmation:* setting this option to `No` causes all strings to be replaced without prompting.

*Search only marked block:* setting this option to `Yes` restricts the search to a marked block of slots.



*Search from current file:* setting this option to **Yes** performs the search and replace operation throughout a multi-file document, starting at the top of the current file.

*Search all files in list:* setting this option to **Yes** performs the search and replace operation throughout a multi-file document, starting at the top of the first file. See **Multi-file documents**, p. 128.

---

## Other block operations

### Word Count – ◊BWC

Counts the words in the whole document, or in a block of slots if one has been marked, and displays the number of words, for example

127 words

at the top of the screen. Note that numbers and other symbols separated by spaces will contribute towards the word count.

### New – ◊BNEW

Clears the entire document. The query

Overwrite text?

is given. If you clear the document (by answering **Yes**), this will cancel all file names and multi-file mode, resetting the Options Page options to their defaults, and resetting the screen display to its starting state of six columns, each 12 characters wide.

### Recalculate – ◊A

Recalculates all expression slots throughout the entire document. The order of recalculation is determined by the columns/rows Options Page setting.

---

# Moving about the document – CURSOR

---

PIPEDREAM	End of Slot	◊↔	Next Word	SHIFT ↔	Next Column	<b>TAB</b>	<b>MENU</b>	<b>OZ</b>
BLOCKS	Start of Slot	◊↔	Previous Word	SHIFT ↔	Previous Column	SHIFT <b>TAB</b>	ADVANCE	
<b>CURSOR</b>	Top of Column	◊↕	Screen Up	SHIFT ↕	First Column	◊CFC	↔↔↕↕	SELECT
EDIT	Bottom of Column	◊↕	Screen Down	SHIFT ↕	Last Column	◊CLC	<b>ENTER</b>	ACTION
FILES	Save Position	◊CSP	Cursor Right	↔			<b>ESC</b>	RESUME
LAYOUT	Restore Position	◊CRP	Cursor Left	↔				
OPTIONS	Go to Slot	◊CGS	Cursor Up	↕				
PRINT	ENTER	<b>ENTER</b>	Cursor Down	↕				

The commands on the **CURSOR** menu aim to provide the greatest possible flexibility for moving around a document. Because they are used so frequently, many of them have simple shorthand equivalents, which can save you a lot of time.

You can move to the left or right a character, word, or column at a time, or to the start or end of a slot, or to the first or last column.

You can move up or down the document a row at a time, a screenful at a time, or to the top or bottom of the column.

You can also go directly to a specified slot by giving its coordinates.

The commands on the **CURSOR** menu do not modify the document in any way, with the exception of the **ENTER** command which will add a blank row at the bottom of the document if the cursor was previously at the bottom of the document.

---

## Moving anywhere

### Go to Slot – ◊CGS

Moves the cursor directly to a specified slot. After the prompt

```
Go to slot
```

type the coordinates of the slot you want to move to, followed by **ENTER**. If the slot you specify is off the document, the cursor will be moved as far as possible in the direction of the specified slot.

**Save Position – ⌘CSP**

Saves the cursor position of the line containing the cursor in PipeDream. If you move to a new position, you can jump back to the previous position with the **Restore Position** command. Up to five positions can be saved.

**Restore Position – ⌘CRP**

Moves the cursor to the last position saved. If five positions have already been saved, the **Save Position** command will give a bleep warning.

---

**Moving within a line/slot****Cursor Right – ⇨****Cursor Left – ⇩**

Moves the cursor to the next character in the slot, or the previous character in the slot respectively. **Cursor Left** will have no effect once the cursor reaches the beginning of the slot. **Cursor Right** will continue to move the cursor beyond the end of the slot, scrolling the slot left if it reaches the wrap point for the column.

**Next Word – [SHIFT] ⇨****Previous Word – [SHIFT] ⇩**

Moves the cursor to the first character of the next word in the slot, and the previous word in the slot respectively. If there are no more words in the current slot, **Next Word** will move the cursor to the first character of the next slot. Likewise, if the cursor is at the beginning of a slot, **Previous Word** will move the cursor to the end of the previous slot.

**Beginning of Line – ⌘⇩**

Moves the cursor to the first character position in the slot.

**End of Line – ⌘⇨**

Moves the cursor to the position after the last character in the slot.

---

**Moving within a column****ENTER** – **ENTER**

Moves the cursor down to the next row and to the first character position in the current column. If the cursor is at the bottom of the document, the command will add an extra row to the document.

**Cursor Up** – **↑**  
**Cursor Down** – **↓**

Moves the cursor to the same horizontal position in the previous line and the next line respectively: the cursor remains in the current column. **Cursor Up** will have no effect if the cursor is already on the top line of the document, and **Cursor Down** will have no effect if the cursor is already on the bottom line of the document.

**Screen Up** – **SHIFT** **↑**  
**Screen Down** – **SHIFT** **↓**

Moves the cursor up or down a screenful at a time. With borders displayed this will be five lines at a time.

**Top of Column** – **◇** **↑**  
**Bottom of Column** – **◇** **↓**

Moves the cursor to the top or bottom of the current column in the document respectively.

---

**Moving between columns****First Column** – **◇** **CFC** or **◇** **TAB**  
**Last Column** – **◇** **CLC**

These commands move the cursor to the first or left-most column on the document, and last or right-most column on the document respectively. The cursor stays in the same row, but will be moved to the first (left-most) character position in the specified column.

**Next Column** – **TAB**  
**Previous Column** – **SHIFT** **TAB**

Moves the cursor to the next column on the right, or the previous column on the left, respectively. The cursor remains in the same row, but moves to the beginning of the slot in the new column.

## Summary of PipeDream cursor operations

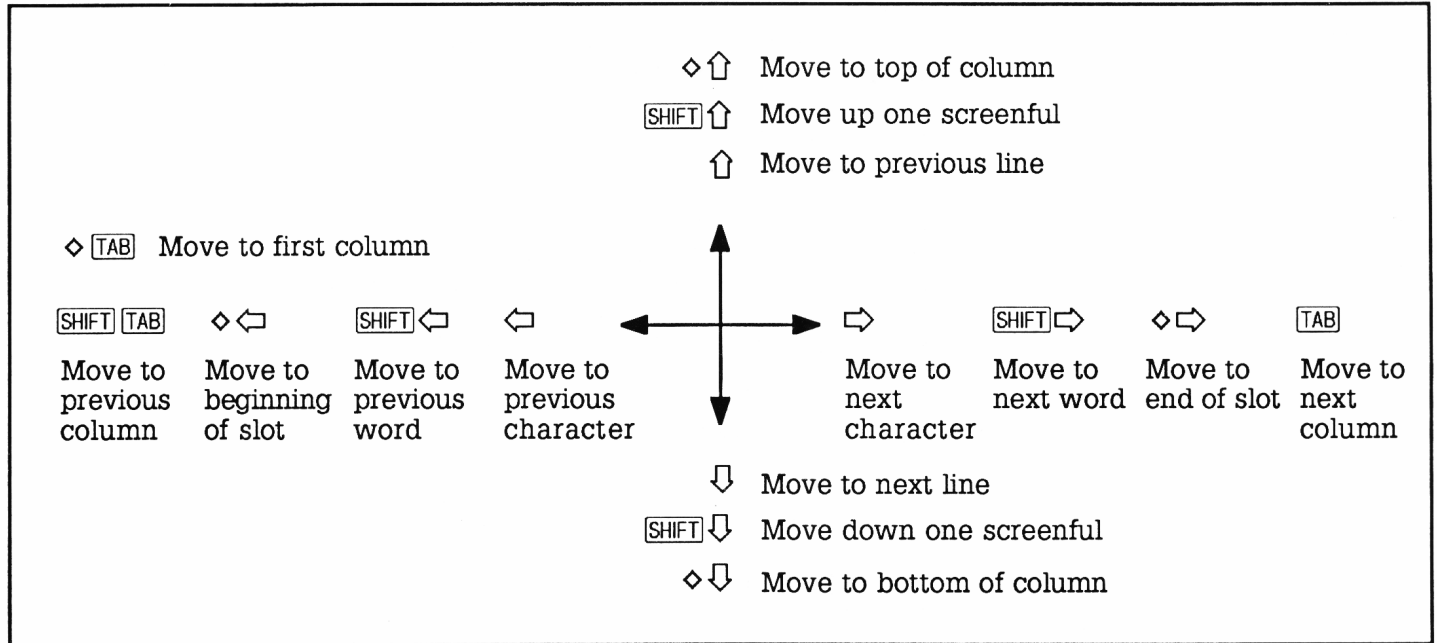

# Editing text and expressions – EDIT

PIPEDREAM	Rubout	DEL	Insert/Overtyp	◊U	Split Line	◊ESL	MENU	OZ
BLOCKS	Delete Character	◊G	Swap Case	◊S	Join Lines	◊EJL	ADVANCE	
CURSOR	Insert Character	◊U	Next Option	◊J	Delete Row in Column	◊EDRC	◊ ◊ ◊ ◊	
EDIT	Delete Word	◊T	Edit Expression	◊X	Insert Row in Column	◊EIRC	SELECT	
FILES	Delete to End of Slot	◊D	Insert Reference	◊K	Delete Column	◊EDC	EDIT	
LAYOUT	Delete Row	◊Y	Number<>Text	◊ENT	Insert Column	◊EIC	ACTION	
OPTIONS	Insert Row	◊N	Format Paragraph	◊R	Add Column	◊EAC	ESC	
PRINT	ESCAPE	ESC			Insert Page	◊EIP	RESUME	

The commands on the **EDIT** menu provide for various modifications on the contents of document. In the first place, there are commands which allow you to delete a character, word, slot, row or column on the document.

You can also insert a row or a column, join two slots or split a slot, and insert a page break.

Some of these commands are especially useful when working with multi-column documents: see **Widths and margins in a multi-column document**, p. 132

The remaining commands are divided into two groups; the first applies specifically to working with text, the second to working with expression slots:

**Format Paragraph** reformats a paragraph of text within a column, **Swap Case** swaps the case of a single character, and **Insert/Overtyp** changes PipeDream between Insert and Overtyp text entry modes.

**Edit Expression** allows you to enter an expression, **Number to Text** converts between an expression slot and a text slot and **Insert Reference** inserts a slot reference into an expression.

## Editing within a line/slot

### Insert/Overtyping – **⌘V**

Switches the text entry mode between Insert and Overtyping. The mode currently selected is displayed on the top line of the Options Page.

In **Insert mode**, characters typed are inserted at the cursor position, and subsequent text on the line moves apart to make space.

In **Overtyping mode**, characters type over any text previously on the same line, in the same way as a correcting typewriter works.

The mode you choose to work in is a matter of personal preference. The selected mode is specific to each PipeDream suspended activity; the default mode can be set in the Panel.

### Rubout – **⌫**

The **Rubout** command, normally used by pressing the **⌫** key, deletes to the left. The **⌫** key is used to remove a mistake in the line you have just typed. In Insert mode the remaining characters on the line move one position to the left. Note that **⌫** will not jump back to the previous line when the left-hand margin of a page is reached.

### Delete Character – **⌘G** or **⇧⌫**

Deletes to the right. You would normally use the **Delete Character** command to delete one or more characters in the middle of a line of text.

### Insert Character – **⌘U**

Inserts a space at the cursor position, leaving the cursor where it is and moving subsequent text on the line to the right. The **Insert Character** command is used when working in Overtyping mode, to create spaces in which to insert additional text within a line.

### Delete Word – **⌘T**

Deletes all the characters from the current cursor position, up to but not including the first character of the next word. Normally you would position the cursor at the beginning of the word you want to delete, using the **Next Word** and **Previous Word** commands, and then give the **Delete Word** command to delete everything up to the next word. Note that **Delete Word** will not delete beyond the end of the current slot.

**Delete to End of Slot – ⌘D**

Deletes all characters from the current cursor position to the end of the slot.

**Swap Case – ⌘S**

Changes the case of the character under the cursor, and moves the cursor one position to the right.

---

**Editing within a column****Delete Row in Column – ⌘EDRC**

Deletes the slot containing the cursor and closes up the gap, so that subsequent rows in the current column move up on the document. This command will typically be used when PipeDream is operating in Columns mode, so that the text in the current column does not have to remain aligned with the text in adjacent columns.

**Insert Row in Column – ⌘EIRC**

Inserts a row in the column containing the cursor. Subsequent rows in the current column are moved down to make space. The **Insert Row in Column** command is typically used when working in Columns mode, as it does not affect the text in columns to either side of the column containing the cursor. It is also useful for restoring the alignment of a table containing items in different columns.

**Join Lines – ⌘EJL**

Joins the text in the line below the current line onto the end of the current line, and closes up the gap so that subsequent slots in the current column are moved up one row.

**Split Line – ⌘ESL**

Splits the current line at the cursor position. The character at the cursor position and subsequent characters are moved to the next row and the cursor remains at the end of the current slot.

**Format Paragraph – ⌘R**

Reformats text from the line containing the cursor to the end of the paragraph. The lines of text will be split at the last space before the



right-hand margin for the current column; see **Starting PipeDream**, p. 32. If justification has been selected, with the Options Page *Justify* option (see p. 140), additional spaces will be added to each line to make the right-hand end always coincide with the wrap point. The end of the paragraph is determined by one of the following:

A line beginning with at least one space

An expression slot

A slot with alignment other than free align; in other words, left align, right align or LCR align.

You can prevent words from being split at a space by typing  $\diamond$ space, which is called an 'exact space' and is displayed on the screen as '...'. For example,

27...KHz

## Editing a document

### Delete Row – $\diamond$ Y or $\diamond$ DEL

Deletes the row containing the cursor across the entire document, closing up the gap. This command should be used with care, since the slot in every column on the current row will be deleted. The command is typically used when PipeDream is operating in Rows mode, in order to maintain alignment between text in adjacent columns.

### Delete Column – $\diamond$ EDC

Deletes the column containing the cursor. Note that all information in the column will be lost, so use this command with caution.

### Insert Page – $\diamond$ EIP

Normally, page breaks are inserted automatically by PipeDream. These are called 'soft' page breaks, and are represented by a horizontal line

^^

across the document between two rows. Their position will change if you alter the amount of text on a page, or change the margin settings on the Options Page.

However, to force a page break to occur at a specific place in the document, such as before a new chapter, you can insert a 'hard' page break with the **Insert Page** command. Hard page breaks are displayed as a row on the document

~~~~~

Using this command will insert a hard page break in the row containing the cursor. The command gives the prompt

Specify no. of unbroken lines      No

Pressing **ENTER** executes the command, thereby ensuring that subsequent text will always start at the top of a new page.

Alternatively, altering the option to **Yes** followed by a number enters a conditional hard page break. This means that a page break will occur if less than the specified number of lines is available on the current page. For example, before a table of ten lines one might insert a conditional hard page break with a value of 10 to ensure that all ten lines of the table were on the same page.

If the conditional hard page break does not cause a page break, it will be displayed in column A as:

~n

### **Insert Row – ◊N**

Inserts a blank row across the entire document before the row containing the cursor. Subsequent rows are moved down to make space. The **Insert Row** command is typically used when working in Rows mode (see the Options Page), since it maintains alignment between text in adjacent columns.

### **Insert Column – ◊EIC**

Inserts a blank column to the left of the column containing the cursor. The new column is created with an initial width of 12 characters, and an initial wrap-width of zero. The cursor remains in the new column.

**Add Column – ⌘EAC**

Adds a blank column at the right-hand side of the document. The new column is added with an initial width of 12 characters, and a wrap-width of zero so that text in the new column will wrap at the right-hand edge of the column.

**Editing expression slots****Insert Reference – ⌘K**

Enables expressions to be built up by indicating, or ‘pointing to’, various slots to which an expression will refer. It inserts the coordinates of the slot containing the cursor into the expression being edited. To perform the command, move the block cursor to the required slot using the cursor keys, and type ⌘K.

If an expression is not being edited, this command will have no effect.

**Edit Expression – ⌘X**

Sets the slot containing the cursor to an expression slot, or edits an existing expression slot.

The slot is highlighted, and the cursor moves to the editing line above the top border at the centre of the screen. The current contents of the slot, if any, are displayed, and they can be edited using the cursor keys and line editing commands:

|                         |                               |
|-------------------------|-------------------------------|
| <b>DEL</b>              | Rubout                        |
| <b>SHIFT DEL</b>        | Delete character              |
| <b>⌘V</b>               | Insert/Overtyp                |
| <b>⌘U</b>               | Insert character              |
| <b>⌘T</b>               | Delete word                   |
| <b>⌘D</b>               | Delete to end of slot         |
| <b>⌘K</b>               | Insert reference              |
| <b>←, →</b>             | Cursor left/Cursor right      |
| <b>SHIFT ←, SHIFT →</b> | Previous word/Next word       |
| <b>⌘←, ⌘→</b>           | Beginning of line/End of line |

Finally press **ENTER** to enter the expression into the slot and display its value, or **ESC** to leave the slot’s previous value unaltered.

**Escape – [ESC]**

Exits from the Options Page, or from the options of any PipeDream command. [ESC] will also abandon the editing of an expression and leave the contents of the slot being edited unchanged.

**Number < > Text – ⋄ENT**

Converts the slot containing the cursor between an expression slot and a text slot. This command allows a number inadvertently entered as text to be converted to an expression, or the equation in an expression slot to be displayed as text so that it can be printed out.

The following procedure can be used to display, or print out, all the expressions within a particular area of a spreadsheet or document:

- ① Save the document first, as the procedure will alter it.
- ② Mark as much of the document as you wish to examine or print out.
- ③ Type ⋄ENT. Expression slots within the marked block will display the expressions they contain. Note that text slots will display the error Typing error.
- ④ Press ⋄Q to clear the marked block, and, if necessary, increase the column widths so that the full expressions can be seen.

---

# Working with files – FILES

---

|                                                                                     |                      |                   |                                                       |                          |                                                                      |           |
|-------------------------------------------------------------------------------------|----------------------|-------------------|-------------------------------------------------------|--------------------------|----------------------------------------------------------------------|-----------|
| PIPEDREAM<br>BLOCKS<br>CURSOR<br>EDIT<br><b>FILES</b><br>LAYOUT<br>OPTIONS<br>PRINT | Load<br>Save<br>Name | ◊FL<br>◊FS<br>◊FC | Next File<br>Previous File<br>Top File<br>Bottom File | ◊FN<br>◊FP<br>◊FT<br>◊FB | <b>MENU</b><br>ADVANCE<br>SELECT<br>ENTER<br>ACTION<br>ESC<br>RESUME | <b>OZ</b> |
|-------------------------------------------------------------------------------------|----------------------|-------------------|-------------------------------------------------------|--------------------------|----------------------------------------------------------------------|-----------|

The commands on the **FILES** menu allow you to load documents from the Z88 filing system, and save documents to the filing system.

You can create a document consisting of several files linked together by a List file. Commands are available to move to the next file or previous file, or go directly to the first file or last file in a multi-file document.

For simple use of PipeDream you do not need to use files, since you can leave documents you are working on as suspended applications. However, since there is a small overhead in keeping suspended applications, saving a large number of small documents as files will prevent the inconveniences of memory low conditions.

---

## File names

When you start PipeDream with a blank document, the document will have no File name associated with it, and it will show:

**File No File**

at the top right-hand side of the Options Page. A File name can be given to a document with the **Name** command. Loading a file, with the **Load** command, will set the File name to the name of the loaded file.

The File name of the document is displayed in the Options Page, and is used as the default file name in the options for the **Save** and **Name** commands. The File name is also used to label PipeDream suspended activities, in the Index YOUR REF. column.

**Name – ◇FC**

Sets the File name for the current document. Gives the prompt:

New name of file

The current File name, if any, will be displayed; this should be edited to the new name, followed by `[ENTER]`.

**Loading a document****Load – ◇FL**

Loads a document of a given name from the filing system. The following options are displayed:

|                        |    |
|------------------------|----|
| Name of file to load   |    |
| Insert at slot         | No |
| Limit to range of rows | No |
| Load as plain text     | No |

*Name of file to load*: specifies the file name. If a file of the same name but with the extension '.L' exists, this file is taken as a List file; see **Multi-file documents**, p. 128. If not, the specified file is loaded.

The File name, displayed in the Options Page, will be set to the name of the file loaded. In the case of a multi-file document, this will be the name of the current document, not the name of the List file.

Instead of typing the file name, the file can be selected from the Filer. After typing ◇FL, call the Filer by typing □F, and select the required document using the cursor keys followed by `[ENTER]` (see **Selecting files**, p. 83). You can then return to PipeDream from the Filer by pressing `[ESC]`, and the full file name will have been entered for you. Press `[ENTER]` to load the file.

If the document in memory has been altered since last saving it, the message

Overwrite text?

will be displayed, and the document will only be loaded if Y (or y) is typed. If the document is too large to fit into memory, only the first section will be loaded, and the display will show the message

**Memory full**

*Insert at slot:* appends the file to the document already in memory, either at the specified slot reference, or at the current cursor position if no slot reference is specified. Type **Y** for the option

**Insert at slot** **Yes**

and enter a slot reference.

*Limit to range of rows:* enables files too large for the available memory to be edited by splitting them up into sections. If the option is set to **Yes**, a range of rows can be entered as two numbers separated by a space. Only rows lying between the specified range, inclusive, will be loaded.

*Load as plain text:* if **Yes** is specified, the file is interpreted as plain text. Sections of text on each line separated by tabs are put into successive columns across each row of the PipeDream document.

After loading a document, expression slots are recalculated twice, once to obtain the correct values of constant slots, and then again to ensure that references to constant slots have the correct values. If the document contains complicated forward referencing, it may need further recalculation before the values of slots stabilise.

**Saving a document****Save – ♦ FS**

If none of the options are changed, pressing **ENTER** saves the whole of the current document to the name last set by the **Load** or **Name** commands.

The following options are displayed:

```
Name of file to save
Save only range of columns      No
Save selection of rows          No
Save marked block                No
Save plain text                  No
```

*Name of file to save:* by default, the current File name is displayed, as shown in the Options Page. This can be edited to save the document under a different name.

*Save only range of columns:* altering this option to `Yes` allows you to specify a range of columns. This should be given as two column labels, separated by a space: for example, `A F`. Only the text within the range of columns, inclusive, will be saved.

*Save selection of rows:* altering this option to `Yes` allows you to enter an expression. Only rows for which the expression evaluates to `TRUE` will be saved.

For example, column `E` in an inventory of goods may represent the quantity of each item in stock. To save a copy of the database which excluded out-of-stock items, you would type

```
Save selection of rows           Yes  E1>0
```

All row references in the expression are incremented before the expression is evaluated for each row in the document. So in this example row 6 will be saved if `E6>0`.

*Save marked block:* altering this option to `Yes` specifies that only the marked block of text should be saved.

*Save plain text:* altering this option to `Yes` will save the document as a plain text file, containing no special constructs. The contents of each successive column will be output separated by tab characters, with each row terminated by a return character.

## Multi-file documents

Documents comprised of several different files can be edited and printed as a single document by means of a PipeDream List file.

The List file is a plain text file containing the names of all the files making up the entire document. It should be saved with the *Save plain text* option, with each file name on a separate line.

The List file should be given a name with the extension `.L`. A file with extension `.L` is taken as a List file when loading, and the first document in the list will be loaded.

Any error which occurs during the processing of a multi-file document cancels the multi-file mode after reporting the error, to avoid overwriting files with incorrect text.



The following commands provide a convenient way of moving between files in a multi-file document:

**Next File – ⌘FN**

Loads the next file in a multi-file document, but first saves the current file if it has been altered since the last save command.

**Previous File – ⌘FP**

Loads the previous file in a multi-file document. The current document is saved if it has been altered since last saving it.

**Top File – ⌘FT**

Loads the first file in a multi-file document. The current document is first saved if it has been altered since last saving it.

**Bottom File – ⌘FB**

Loads the last document in a multi-file document. The current document is first saved if it has been altered since last saving it.

**Multi-file example**

For example, first create a List file in PipeDream, containing the following text:

```
A3
.....A.....B.....C.....D.....E.....↓F
1 chapterone
2 chaptertwo
3 chapterthree
  End of text
```

Take care not to add any blank lines after the last file name. Then save this as a plain text file called `book.L`, by typing `⌘FS book.L`, and setting the *Save plain text* option to `Y`.

Create three files, chapterone, chaptertwo, and chapterthree, containing, for example, the following lines of text respectively:

This is the first chapter

This is the second chapter

This is chapter three

Now load the multi-file document by typing **⌘FL** book. If you use the Filer to select the file you will need to delete the **' . L '** extension from the end of the file name.

Typing **⌘FN**, **⌘FP**, **⌘FT**, and **⌘FB** will then move between the three files.

---

# Altering the document layout – LAYOUT

---

|            |              |      |              |       |                     |      |         |    |
|------------|--------------|------|--------------|-------|---------------------|------|---------|----|
| PIPE DREAM | Width        | ◊W   | Right Align  | ◊LAR  | Decimal Places      | ◊LDP | MENU    | OZ |
| BLOCKS     | Set Margin   | ◊H   | Left Align   | ◊LAL  | Sign Brackets       | ◊LSB | ADVANCE |    |
| CURSOR     | Fix Row      | ◊LFR | Centre Align | ◊LAC  | Sign Minus          | ◊LSM | ◄ ◄ ◄ ◄ |    |
| EDIT       | Fix Column   | ◊LFC | LCR Align    | ◊LLCR | Leading Characters  | ◊LCL | SELECT  |    |
| FILES      | Margin Right | ◻ ◄  | Free Align   | ◊LAF  | Trailing Characters | ◊LCT | ENTER   |    |
| LAYOUT     | Margin Left  | ◻ ◄  |              |       | Default Format      | ◊LDF | ACTION  |    |
| OPTIONS    |              |      |              |       |                     |      | ESC     |    |
| PRINT      |              |      |              |       |                     |      | RESUME  |    |

The commands in the **LAYOUT** menu allow you to specify how the information entered in a document is displayed.

You can alter the width that any column occupies, and the column's right-hand margin, which determines the point at which lines of text entered into that column wrap onto the next line.

You can also fix rows above the cursor position and columns to the left of the cursor position so that you can see information on one part of the document while editing information on another part.

---

## Column widths and margins    Width – ◊W

Specifies the width that a column occupies on the document. The following options are displayed:

```
New width
Specify column                               No
```

If no column is specified, the column currently containing the cursor is assumed.

**Set Margin – ⬇H**

Alters the right-hand margin of a specified column. The margin is indicated by the right-hand margin pointer, ↓, on the top border, and determines the point at which text typed into the column will wrap onto the next line.

This command determines the area over which text is to be formatted within the column; thus, if the width is set to zero, it will be equal to the column width, and there will be no margin. The following options are displayed:

```
New width
Specify column                               No
```

If no column is specified, the column containing the cursor will be assumed.

**Margin Left – □←**

**Margin Right – □→**

These commands allow you to move the right-hand margin for a number of columns simultaneously.

The commands move the right-hand margin pointer, ↓, for the column containing the cursor one character position to the left or right respectively. They also set the wrap point of all columns between the current column and the wrap point so that they wrap at the same position.

---

## Widths and margins in a multi-column document

By default, the wrap point for all columns is set to the right-hand edge of the screen, which is most appropriate for creating tables of information within a single column of text. The **Insert on wrap** option on the Options Page is initially set to Rows, ensuring that information in adjacent columns will remain aligned.

It is also possible to create a document with two or more independent columns of text, like the layout of a newspaper.

You do this by moving the right-hand margin for each column to the right-hand edge of the column. Setting the **Insert on wrap** Options Page option to Columns will then ensure that the text in each column can be edited without affecting adjacent columns.

For example, the following steps can be used to create the three-column document shown below.

- ① Set the widths of columns A, B, and C to 24, by giving the **Width** command on the **LAYOUT** menu with the options

```
New width                24
Specify column            Yes A
```

```
New width                24
Specify column            Yes B
```

```
New width                24
Specify column            Yes C
```

- ② With the cursor in column A, move the right-hand margin to the right-hand edge of column A by pressing  $\square \leftarrow$  until the right-hand margin pointer is just to the left of the A on the top border; see the diagram below. This will also position the left margin for columns B and C to the right-hand edge of those columns.
- ③ Enter the Options Page, by typing  $\diamond O$ , and alter the **Insert on wrap** option to Columns by pressing  $\downarrow$  until the cursor is on the option line, and typing C to alter it to

```
Insert on wrap                C
```

Press  $\boxed{\text{ESC}}$  to exit from the Options Page.

- ④ Type the required text into each column; it will format automatically within the column width.

```
A3
1 .....↓A.....B.....C.....
2 1. Send your name and address with a postal order for £20. 2. Within 10 days you will receive your own personal piranha fish. 3. If not completely satisfied, return the fish for a full refund.
3  █End of text
```

## Alignment

Text can be aligned in one of the following ways:

- ① Left-aligned with the left-hand edge of the column.
- ② Right-aligned with the right-hand margin pointer.
- ③ Centred between the left-hand edge of the column and the right-hand margin pointer.
- ④ Components of the line can be left-aligned, centred, and right-aligned (LCR alignment).

Text in a slot which has been aligned with one of the **Align** commands will not be reformatted by the **Format Paragraph** command.

The results of expression slots can similarly be displayed left-aligned, centred, or right-aligned over the width of the column.

### **Right Align** – ◇ LAR

### **Left Align** – ◇ LAL

Aligns the text in the current slot to the right or left of the wrap-width of the current column, respectively. The alignment will be displayed when the cursor is moved off the slot. The **Left Align** command can, for example, be used to prevent text in a table from being inadvertently reformatted with the **Format Paragraph** command.

### **Centre Align** – ◇ LAC

Centres the text in the slot containing the cursor, or a marked block of slots, over the wrap-width of the column containing it.

### **LCR Align** – ◇ LLCR

Aligns components of the slot containing the cursor, or the slots within a marked block, to the left, centre, and right of the column's text wrap-width. The line has the format

```
/left/centre/right/
```

where left, centre, and right represent text which will be respectively left-aligned, centred and right-aligned, and '/' represents an arbitrary delimiter, which must not occur elsewhere in the line of text.

**Free Align – ◊ LAF**

Removes the alignment from a slot containing the cursor, or a marked block of slots. Text, or the results of expression slots, will be left-aligned in the slot.

**Fixing rows and columns**

**Fix Row – ◊ LFR**

Fixes the row containing the cursor, and all rows above it, on the screen. If borders are displayed, the fixed rows are identified with horizontal lines in the left-hand border. Moving the cursor up or down on the document will scroll only those rows which have not been fixed, so the cursor can be moved to another part of the document while retaining the fixed rows on the screen. Giving the **Fix Row** command again frees the rows and restores the document to its original state.

**Fix Column – ◊ LFC**

Fixes the column containing the cursor, and all columns to its left, on the screen. If borders are displayed, the fixed columns are identified in the top border by solid lines. If the cursor is moved on the document, only the columns that have not been fixed will scroll, so that the cursor can be moved to another part of the document while retaining the fixed columns on the screen. Giving the **Fix Column** command again frees the columns.

For example, the top row of headings and leftmost column of labels have been fixed in the following document by giving the commands ◊LFR and ◊LFC with the cursor in slot A1:

| A1 | A.....      | B..... | C..... | D..... | E..... | F..... |
|----|-------------|--------|--------|--------|--------|--------|
| 1  | Mint chips  | 25     | 34     | 33     | 45     | 49     |
| 2  | Choc browns | 10     | 9      | 11     | 23     | 7      |
| 3  | Sponges     | 35     | 37     | 34     | 36     | 19     |
| 4  | Flapjacks   | 5      | 6      | 3      | 4      | 6      |
| 5  | Queen cakes | 124    | 145    | 167    | 189    | 234    |

The cursor can then be moved around to scroll the document while keeping the column headings and row labels in view.

## Number formats

Expressions can be displayed with a specified number of decimal places, or in free format. Negative numbers can be displayed either with a minus sign, or with brackets as in financial notation. The results of expression slots can also be displayed with one or more leading characters, such as 'f' and one or more trailing characters, such as '%'. The leading and trailing characters for the document are specified in the Options Page.

The format in which any expression slot is displayed can be restored to the default specified in the Options Page by the **Default Format** command.

All the format commands can be applied either to the single slot containing the cursor, or to a block of slots by marking them before giving the command.

### Decimal Places – ◇LDP

Sets the number of decimal places displayed by an expression slot, or a marked block of expression slots. Gives the prompt

```
Number of decimal places
Floating format                No
```

The number of decimal places may be set to a value from 0 to 9, or floating format may be specified which uses the display format giving the most significant figures displayed in the available width.

### Sign Brackets – ◇LSB

### Sign Minus – ◇LSM

Specify that negative values in an expression slot or marked block of expression slots should be displayed in financial notation, enclosed in brackets, or with a minus sign prefix respectively.

### Leading Characters – ◇LCL

### Trailing Characters – ◇LCT

Specify that the leading or trailing characters defined in the Options Page should be displayed for the expression slot contained in the cursor or the marked block of expression slots. The default leading and trailing characters are 'f' and '%' respectively, and these can be altered on the Options Page.



**Default Format – ◇LDF**

Restores the expression slot containing the cursor, or a marked block of expression slots, to the default format as specified on the Options Page. Once any element of an expression slot's format has been altered with one of the commands **Decimal Places**, **Sign Brackets**, **Sign Minus**, **Leading Characters** or **Trailing Characters**, the slot's format is frozen and will not be affected by subsequent alterations to the Options Page. Giving the **Default Format** command removes any specific format set on the slot.

---

# Document options – OPTIONS

---

|                                                                                            |              |    |                                                                                               |           |
|--------------------------------------------------------------------------------------------|--------------|----|-----------------------------------------------------------------------------------------------|-----------|
| <b>PIPEDREAM</b><br>BLOCKS<br>CURSOR<br>EDIT<br>FILES<br>LAYOUT<br><b>OPTIONS</b><br>PRINT | Options Page | ◇O | <b>MENU</b><br>ADVANCE<br>← → ↓ ↑<br>SELECT<br><b>ENTER</b><br>ACTION<br><b>ESC</b><br>RESUME | <b>OZ</b> |
|--------------------------------------------------------------------------------------------|--------------|----|-----------------------------------------------------------------------------------------------|-----------|

The **OPTIONS** menu contains only one command, **Options Page**, or ◇O, which displays a page of information about the current document together with the global settings which may be altered to effect the way that commands operate on the document.

|                |                  |                |              |        |
|----------------|------------------|----------------|--------------|--------|
| Text/Numbers T | Insert on wrap R | Margins: Top 0 | File No File |        |
| Borders Y      | Calc: Auto/Man A | Header 2       | Page 1       | Insert |
| Justify N      | Columns/Rows C   | Footer 2       | Free 20480   |        |
| Wrap Y         | Decimal places 2 | Bottom 8       |              |        |
| Page length 66 | Minus/Brackets M | Left 0         | Title        |        |
| Line spacing 1 | Lead chs. %      | Header         |              |        |
| Start page     | Trail chs. %     | Footer         |              |        |

You can return to a PipeDream document by pressing the **ESC** key.

---

## Information lines

The right-hand column of the Options Page display gives information about the current document.

### File

The name of the document previously loaded with the **Load** command, or the name assigned to a document by the **Name** command (◇FC) on the **FILES** menu. If no name has been specified, it will show

### No File

The name will also appear on the **SUSPENDED ACTIVITIES** list in the Index display.

**Page**

Shows the current page number of the line containing the cursor. This will correspond to the page numbering when the document is printed unless rows are fixed with the **Fix Row** command on the **LAYOUT** menu, or the Options Page page-length setting has been set to zero.

**Insert/Overtyp**

Shows the current text entry mode selected by the **Insert/Overtyp** command on the **EDIT** menu. The mode initially selected is Insert mode.

**Microspace**

Normally blank, displays the word **Microspace** if the microspace option has been selected from the **PRINT** menu.

**Free**

Displays the amount of space remaining for characters in the current document, to the nearest multiple of 256 characters. It is inadvisable to continue typing text into a document if there are less than approximately 300 free characters. In such a situation you are advised to make space in memory by freeing activities, or deleting files.

---

**Option lines**

This page is used to determine how text and expressions are displayed in a document (including the default setting for the display of expression results) and to set up the layout of a document ready for printing, specifying headers and footers, and margins at the top, bottom and left of the page. In addition, you can control the length of the page, the spacing of text, and the page numbering.

**Altering options – Next Option**

As with many other commands, Next Option, **◇J** will alternate between two available values, for example **Y** and **N** for **Yes** and **No**, or **T** and **N** for **Text** and **Numbers**. Alternatively, these values can be changed by typing the appropriate letter. In the case of options with more than two possible values, **◇J** will set the option back to its default value.

Other options can be altered by moving the cursor to the appropriate item, with the **↑** and **↓** keys, and then editing the item with the line-

editing commands  $\leftarrow$ ,  $\rightarrow$ ,  $\boxed{\text{DEL}}$  key and  $\diamond G$  or  $\boxed{\text{SHIFT}} \boxed{\text{DEL}}$  to delete the character under the cursor. In numeric fields, such as **Page length**, Overtyping mode is automatically set irrespective of the current Overtyping/Insert mode setting.

In the following list of options the default value is shown against each option.

---

## Text format

Determines the formatting of text in the document.

### Text/Numbers (T)

Set to **T** (Text) to make the default slot format text slots, or **N** (Numbers) for expression slots. In Numbers mode there is no need to type  $\diamond X$  before entering an expression, and the cursor keys  $\rightarrow$  and  $\leftarrow$  will move directly between slots containing expressions; ie behave like  $\boxed{\text{TAB}}$  and  $\boxed{\text{SHIFT}} \boxed{\text{TAB}}$ .

### Borders (Y)

Set to **Y** (Yes) to display borders, or **N** (No) to hide borders. Hiding the borders allows a larger area of the sheet to be displayed, and can be useful for word-processing applications.

### Justify (N)

Set to **N** (No justify) for ragged right margins, or **Y** (Yes) for even right-hand margins. To reformat a paragraph of text after changing this option, give the **Format Paragraph** command,  $\diamond R$ .

### Wrap (Y)

Set to **Y** (Yes) to make text wrap automatically at the wrap point, or **N** (No) for no wrapping.

### Insert on wrap (R)

Set to **R** (Rows) to maintain alignment between adjacent rows, or **C** (Columns) for creating independent columns of text; see **Widths and margins in a multi-column document**, p. 132.

---

**Recalculation mode**

The **Calc** options determine how expression slots are recalculated in the document.

**Auto/Man (A)**

Determines the recalculation of expression slots on the document.

Set to **A** (Automatic) to recalculate the document every time an expression slot changes or **M** (Manual) for recalculation only with the **⌘A** command. This option can be set to **M** to make entering data into a large spreadsheet, or working with large text documents, faster.

**Columns/Rows (C)**

Select the order of recalculation: **R** (Rows) across rows first, or **C** (Columns) down columns first.

---

**Number formats**

Determine the default display format for numerical expression slots.

**Decimal places (2)**

Select 0 to 9 decimal places or **F** for free format.

**Minus/brackets (M)**

Select **M** (Minus) to display negative numbers with a minus sign, or **B** (Brackets) for financial bracketed notation.

**Lead chs. (£)****Trail chs. (%)**

Specify up to 4 characters to be displayed in front of or after expression slots with **⌘LCL** or **⌘LCT** set.

**Page format**

Determines the spacing and pagination of the document when printed.

**Page length (66)**

Set to between 1 and 127 to specify the number of lines on each page, including margins, footer and header, or 0 to suppress page breaks altogether.

**Line spacing (1)**

You can specify from 0 to 255 additional blank lines to be inserted between each line of text.

**Start page**

You can set the current page number to 0 to 255.

---

**Headers, footers, and margins**

You can specify an additional header or footer line of text to appear at the top or bottom of each printed page respectively. Each line of text can consist of up to three components, which will be left-aligned, centred, and right-aligned.

The left margin, and the margins above and below the header and footer, and between the header and footer and the page of text, can be separately altered to determine the layout of the printed page.

Note that if a header or footer are specified, the number of lines of text on each page will be reduced accordingly.

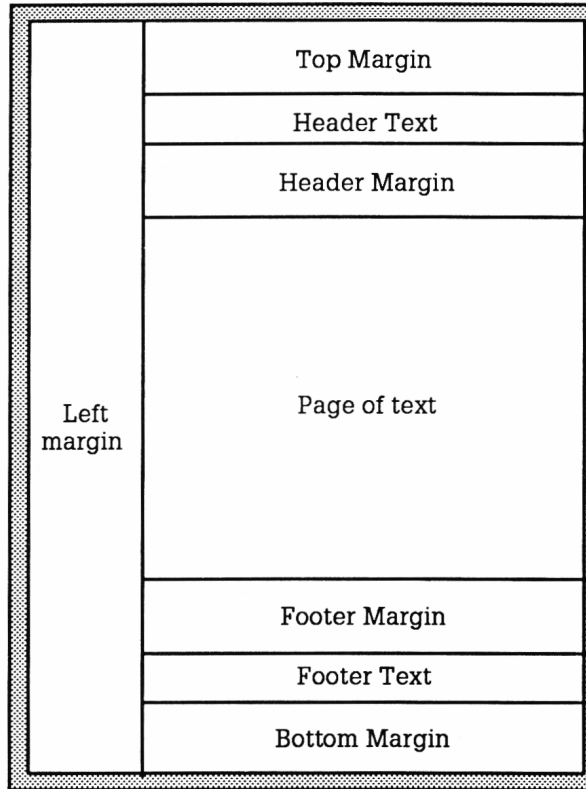

The complete page layout, with headers and footers and their associated margins, will be represented on the page map display at the right-hand side of the PipeDream screen.

**Header**  
**Footer**

You can specify lines of text which will be printed out at the head and foot of each page. Each line has the format

```
/left/centre/right/
```

where left, centre, and right represent text which will be respectively left-aligned, centred and right-aligned, and '/' represents an arbitrary delimiter, which must not occur elsewhere in the line of text.

---

## Title

A line of up to 244 characters can be entered in this field as a title for the document. The title can be included in the document, or in the footer or header, by giving the @T@ field; see p. 158.

---

## Margins

You can specify the number of blank lines, from 0 to 255, to be left above the header, between header and text, between text and footer, and below the footer respectively. The left margin can specify a margin of 0 to 255 characters at the left of each page:

```
Margins: Top 0
          Header 2
          Footer 2
          Bottom 8
          Left 0
```

For example, a typical set-up might be

```
Margins: Top 2
          Header 2
          Footer 2
          Bottom 2
          Left 6
          Header /@T@//Maxo Ltd/
          Footer //Page @P@//
```

Title Quarterly Report

The @-field @P@ will be replaced by the current page number, and the @-field @T@ by the Title. The resulting page layout would be as follows:



Quarterly Report

Maxo Ltd

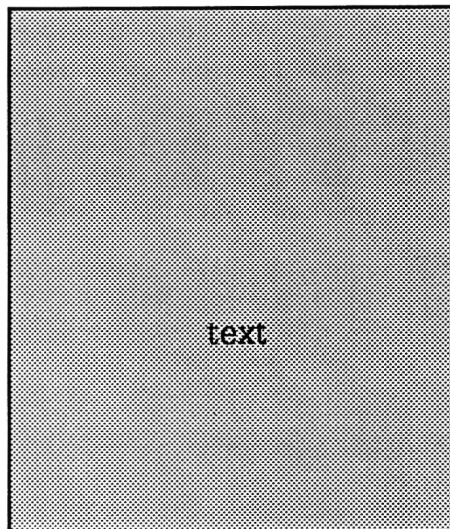

text

Page 1

# Printing documents – PRINT

|           |                  |     |               |     |                   |      |         |    |
|-----------|------------------|-----|---------------|-----|-------------------|------|---------|----|
| PIPEDREAM | Print            | ◇PO | Underline     | ◇PU | Insert Highlights | ◇PHI | MENU    | OZ |
| BLOCKS    | Microspace Pitch | ◇PM | Bold          | ◇PB | Remove Highlights | ◇PHR | ADVANCE |    |
| CURSOR    |                  |     | Ext. Sequence | ◇PX | Highlight Block   | ◇PHB | ⬅ ➡ ⬆ ⬇ |    |
| EDIT      |                  |     | Italic        | ◇PI |                   |      | SELECT  |    |
| FILES     |                  |     | Subscript     | ◇PL |                   |      | ENTER   |    |
| LAYOUT    |                  |     | Superscript   | ◇PR |                   |      | ACTION  |    |
| OPTIONS   |                  |     | Alt. Font     | ◇PA |                   |      | ESC     |    |
| PRINT     |                  |     | User Defined  | ◇PE |                   |      | RESUME  |    |

The commands on the **PRINT** menu allow you to print your document and to take advantage of facilities offered by the printer, such as bold and underlined text, and alternative fonts.

## Print – ◇PO

Prints all or part of a document. The following options are displayed:

|                             |    |
|-----------------------------|----|
| Print only range of columns | No |
| Select rows to print        | No |
| Wait between pages          | No |

By default, the **Print** command prints the whole of the current document with no pause between pages.

The starting page number is determined by the Options Page **Start page** setting, except when printing a marked block, or selected rows. In this case the pages will be numbered, starting at 1, and soft page breaks will be ignored.

*Print only range of columns:* setting this option to **Yes** will allow a column range to be specified. The column range should be given as two column labels, separated by a space. Only the columns within the specified range (inclusive) will be printed.

*Select rows to print:* setting this option to **Yes** will allow an expression to be entered. Rows will only be printed if the expression evaluates to a true or non-zero result. The expression can contain slot references; after each row the slot references are updated by one row, unless they are fixed with the \$ operator.

For example, a document containing text in column B could use column A to contain a '\*' character, indicating the latest revisions to the document. To print out only the revised lines the option

```
Select rows to print          Yes A1="*"
```

could be specified. See also **Printing selected rows**, p. 54, for an example.

*Wait between pages*: setting this option to **Yes** gives a prompt between pages to allow single sheets to be inserted into the printer. The prompt

```
Page n . .
```

is displayed, where *n* is the page number. You can then press one of the following keys to control printing:

M to miss the page

C to continue printing all remaining pages without further prompting

Any other character (eg the space bar) to print the page

[ESC] to abandon printing.

*Printing a marked block*: if a block of slots is marked when the **Print** command is given, only the marked slots will be printed.

*Multi-file documents*: if the **Print** command is given in a multi-file document, the current document will be saved if it is modified, and the entire multi-file document will be printed, starting with the first file.

### Microspace pitch – ◊PM

Selects microspaced printed output. Gives the prompt

```
Microspace printed output      No
```

Changing the option to **Yes** and pressing [ENTER] causes subsequent output to be microspaced at the default spacing of 12/120ths of an inch, giving a pitch of 10 characters per inch. A number can be entered to specify an alternative spacing. For example, entering 10 gives 12 characters per inch. **Microspace** is displayed at the top right-hand corner of the Options Page display if it has been selected.

## Highlighting text

You can alter the style of text in your document by inserting one of eight highlight codes in front of the text, and the same code after the text to revert back to normal.

### Highlight codes

The recommended assignment of the eight codes is as follows:

| Code | Function          | Printed example        |
|------|-------------------|------------------------|
| 1    | Underline         | <u>underlined type</u> |
| 2    | Bold              | <b>bold type</b>       |
| 3    | Extended sequence | é ç π                  |
| 4    | Italic            | <i>italic type</i>     |
| 5    | Subscript         | H <sub>2</sub> O       |
| 6    | Superscript       | e=mc <sup>2</sup>      |
| 7    | Alternative font  | alternative font       |
| 8    | User defined      |                        |

To obtain the right results when these codes are printed you may need to create a printer driver; see **Section Nine – The Printer Editor**.

The codes are inserted into text with the following commands:

**Underline (1)** – ◇PU

**Bold (2)** – ◇PB

**Extended Sequence (3)** – ◇PX

**Italic (4)** – ◇PI

**Subscript (5)** – ◇PL

**Superscript (6)** – ◇PR

**Alternative font (7)** – ◇PA

**User Defined (8)** – ◇PE

These commands insert the corresponding highlight code at the current cursor position. Successive occurrences of a highlight code enable and disable the corresponding printer facility.

The effect of highlights 1, 2, 3, and 4 (underline, bold, extended sequences, and italic text styles) are displayed on the screen as underlined, bold, grey, and tiny characters respectively when the cursor is moved onto another slot. When the cursor is on the same slot, all highlight codes are displayed as the corresponding highlighted numbers **1** to **8**.

Highlight characters are considered to be of zero width for formatting and justification.

*Note:* You can use `◇SPACE` to create an 'exact space' character. This may help to create continuous underlining of titles etc.

### **Insert Highlights – ◇PHI**

Inserts a specified highlight number in the text at the cursor position. Gives the prompt

`Highlight number`

Typing in a number between 1 and 8, followed by `ENTER`, will insert the corresponding highlight code into the text.

### **Remove Highlights – ◇PHR**

Removes all occurrences of a specified highlight number from a given marked block of text. Gives the prompt

`Highlight number`

Typing a number between 1 and 8 followed by `ENTER` will remove all occurrences of the corresponding highlight from the marked block.

### **Highlight Block – ◇PHB**

Highlights all words within a marked block of text with a given highlight number. Gives the prompt

`Highlight number`

Typing a number between 1 and 8 will remove any existing highlights of the same number and highlight all words in the marked block with pairs of the specified highlight character. Because individual words are highlighted, reformatting the highlighted block of text will leave the selected text correctly highlighted, and text will be printed correctly even if the highlighted block extends over a page break.

---

# Expression slots

---

Any slot in a PipeDream document can be designated as an expression slot, in which case the expression you type into it will be evaluated, and the result will be displayed in the corresponding position in the document.

An expression is entered by giving the **Edit Expression** command on the **EDIT** menu, or by typing  $\diamond X$ . The cursor will then move to the editing line, at the top of the screen, until the expression is entered by typing `ENTER`.

Alternatively, if the Options Page **Text/Numbers** option is set to **N**, all entries are taken as expressions.

---

## Expressions

Expressions can consist of numbers, functions performing operations on other expressions, references to other slots, or a combination of these combined by mathematical operators. Expressions can give a numerical result, a date, or a string of text. Illegal expressions will give an error as their result.

### Numbers

Numbers can be expressed in normal notation, or scientific notation. For example,

1, -1.7632, 1.4e27, 0.001

All calculations are performed to an accuracy of nine decimal places and numbers may lie between 1e38 and 1e-38.

### Strings

Strings are entered between double quotes, and may contain spaces. A slot reference to a text slot returns a string.

### Slot references

The form of a slot reference is

*column-label row-number*

separated by optional spaces, where

*column-label* designates one of the 64 columns, A to Z, followed by AA to BN, and

*row-number* is from 1 to 32768.

Slot references are normally 'relative'; the reference will be updated if the position of the slot containing the reference changes relative to other slots.

Each half of the slot reference may be 'fixed' by preceding the column letter or the row number by a dollar sign. The possibilities are:

|        |                         |
|--------|-------------------------|
| A1     | normal reference        |
| \$A1   | fixed column reference  |
| A\$1   | fixed row reference     |
| \$A\$1 | fixed column, fixed row |

The fixed part of a reference is not altered when copied with the **Replicate** or **Copy** commands on the **BLOCKS** menu, or when placed in a selection expression for the **Save** and **Print** commands on the **FILES** and **PRINT** menus respectively.

When a slot to which a slot reference refers is deleted, the slot reference is marked with a '%' sign to indicate that the reference is no longer valid. The expression containing the slot reference will display the **Bad slot** error message.

### Specifying a block of slots – Ranges

You can perform some functions on a block of slots, specified by the top left-hand corner of the block followed by the bottom right-hand corner of the block.

For example

A2 D8

specifies all the slots in the block between columns A and D, and rows 2 and 8 inclusive.

In some cases the function only makes sense if the range is restricted to a single row (a 'row range') as in A1 D1, or a single column (a 'column range'), as in B8 B20.

### Specifying several slots – Lists

Functions are available to count, choose from, or find the maximum or minimum of a list of elements. The elements in a list are separated by commas and can be simple slot references, or ranges. Each slot in a range is considered as a separate list element. For example,

13, B1 B5, C7,

is a list containing the 7 elements 13, B1, B2, B3, B4, B5, and C7.

### Dates

Dates are entered in the format

*DD.MM.YYYY* or *MM.DD.YYYY*

depending on whether the Panel date-format setting is European or American.

Dates can be sorted into chronological order, and the functions DAY, MONTH, and YEAR can be used to extract the values of the date's day, month, and year respectively.

---

## Operators

The following operators can be used within expressions

### Arithmetic

The arithmetic operators take two numbers as operands.

|   |                    |   |          |
|---|--------------------|---|----------|
| + | add                | - | subtract |
| * | multiply           | / | divide   |
| ^ | raise to the power |   |          |

Also, '+' and '-' may be used on date values. For example

12.10.1987 + 127



will return the date 127 days after 12 October 87, or 16.2.88, assuming that European date format has been selected.

### Relational

The relational operators can compare dates, strings, and numbers. Both operands must be of the same type, and the result is a logical value of FALSE=0 and TRUE=1.

|    |                       |    |                          |
|----|-----------------------|----|--------------------------|
| <  | less than             | =  | equal to                 |
| <= | less than or equal to | >  | greater than             |
| <> | not equal to          | >= | greater than or equal to |

When strings are being compared, the following wildcards (as in the **Replace** command) can be included in the second string:

|    |                                  |
|----|----------------------------------|
| ^? | matches any single character     |
| ^# | matches any number of characters |
| ^^ | represents ^                     |

### Logical

The logical operators operate on numeric or logical values. Boolean FALSE is taken as zero, TRUE as non-zero.

|   |           |   |    |
|---|-----------|---|----|
| & | AND       | ; | OR |
| ! | unary NOT |   |    |

---

## Functions

### ABS Absolute value

ABS(number)

Returns the absolute positive value of the argument.

### ACS Arc cosine

ACS(number)

Returns the arc cosine of the argument, in radians.

**ASN Arc sine**

ASN(number)

Returns the arc sine of the argument, in radians.

**ATN Arc tangent**

ATN(number)

Returns the arc tangent of the argument, in radians.

**CHOOSE Choose element from list**

CHOOSE(list)

Returns an element from the list, using the value of the first element as an index into the remaining elements. For example, if B4 contains  
17.2.1987

CHOOSE (MONTH(B4), "jan", "feb", "mar", "apr")

gives the result **feb**.**COL Column**

COL

The value of the column in which it is evaluated. Column A is 1, column B is 2, etc.

**COS Cosine**

COS(radians)

Returns the cosine of the argument.

**COUNT Count the number of elements**

COUNT(list)

Returns the number of non-blank slots in the list.

**DAY Day of date**

DAY(date)

Returns the day number of a date argument.

For example, if slot A1 contains 17.3.1961, then DAY(A1) returns 17

**DEG Degrees from radians**

DEG(radians)

Converts the argument, taken in radians, into degrees.

**EXP Exponent**

EXP(number)

Returns the constant e (2.71828184..) raised to the specified power.

**IF Conditional expression**

IF(boolean,then,else)

If the value of the first argument is TRUE, ie non-zero, the function returns then; otherwise the function returns else.

For example, if slot A1 contains -23,

IF(A1<0,"Debit","Credit")

would return Debit.

**INDEX Index slot**

INDEX(column,row)

Returns the evaluated expression or string found at coordinates column, row. For example, if A2 contained IF(100,"Debit","Credit")

INDEX(1,2)

would return Credit.

**INT Integer part**

INT(number)

Returns the integer part of the argument.

**LN Logarithm to base e**

LN(number)

Returns the natural logarithm,  $\log_e$  of the argument.**LOG Logarithm to base 10**

LOG(number)

Returns the logarithm to base 10 of the argument.

**LOOKUP Look up value in a table**

LOOKUP(key,range1,range2)

Returns the value in range2 corresponding to the position that key occurs in range1.

key must be a cell reference. For example, the following sheet would result if LOOKUP(A3, A1 F1, A2 F2) were placed at B4:

|    |                          |     |     |     |     |     |
|----|--------------------------|-----|-----|-----|-----|-----|
| B4 | LOOKUP(A3, A1:F1, A2:F2) |     |     |     |     |     |
|    | A                        | B   | C   | D   | E   | F   |
| 1  |                          |     |     |     |     |     |
| 2  | 111                      | 222 | 333 | 444 | 555 | 666 |
| 3  |                          |     |     |     |     |     |
| 4  | End of text              | 555 |     |     |     |     |

If an exact match is found in range1, the function returns the value of the slot the same number of slots from the beginning of the second range.

If key is not found in range1, the function returns the error

**Lookup**

Wildcards '^?' and '^#' may be included in key.

**MAX Maximum value in list**

MAX(list)

Returns the maximum value from the slots in the list.

**MIN Minimum value in list**

MIN(list)

Returns the minimum value from the slots in the list.

**MONTH Month of date**

MONTH(date)

Returns the month number of its date argument.

For example, if A1 contains 12.6.1987 then MONTH(A1) returns 6.

**PI  $\pi$** 

PI

Returns the value 3.141592653.

**RAD Radians from degrees**

RAD(degrees)

Returns the argument, taken as degrees, converted into radians.

**ROW Row**

ROW

The value of the row in which it is evaluated.

**SGN Sign**

SGN(number)

Returns -1, 0, or 1 depending on whether the argument is negative, zero, or positive respectively.

**SIN Sine**

SIN(radians)

Returns the sine of the argument, in radians.

**SQR Square root**

SQR(number)

Returns the positive square-root of its argument.

**SUM Sum**

SUM(list)

Returns the sum of the slots in the list.

**TAN Tangent**

TAN(radians)

Returns the tangent of the argument, in radians.

**YEAR Year of date**

Returns the year number of its date argument.

For example, if A1 contains 12.6.1987 then YEAR(A1) returns 87.

**@ Fields**

You can include the page number, the date, the file title from the Options Page, or the value of any expression slot within text in your document using the special PipeDream @-fields.

The following @ fields are available:

| Identifier | Effect                        |
|------------|-------------------------------|
| @P@        | current page number           |
| @D@        | date                          |
| @T@        | title defined in options page |
| @ref@      | value of slot <i>ref</i>      |
| @@         | @                             |

---

One or more '@' characters should be given after the identifier to determine the size of the @ field for formatting. For example,

@P@@@@

creates a field of four characters. Provided the value to be displayed is less than the size of the @-field, the line will be justified correctly.

The field:

@ref@@@@

will reserve five characters for the value of the slot indicated by the reference.

If it is an expression slot, the value will be displayed in the same format as in the slot itself, with alignment ignored.

When the cursor is not on a text slot with an @ field in it, the slot shows the value of the @ field. When the cursor is moved onto the slot, the actual @ identifier is shown, for editing.





---

## Section Six

# The Diary reference

---

The Diary application can be entered from the Index menu or from any application by typing `␣D`. Only one copy of the Diary can exist in the list of SUSPENDED ACTIVITIES at any time.

The Diary displays the Diary page for the current date, or the page previously edited if there is one.

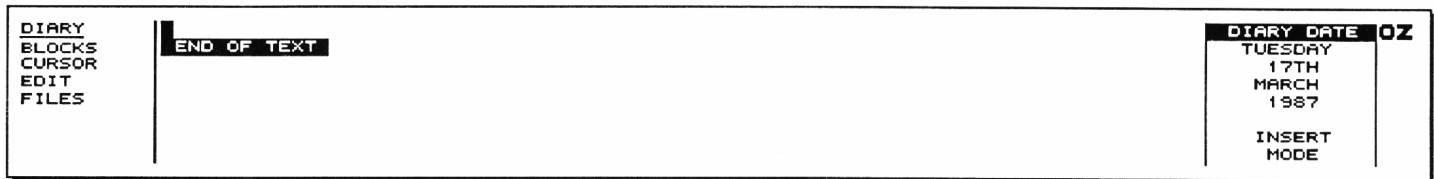

Text can be typed into the diary in a free format, and can be edited using similar cursor-editing facilities as in PipeDream. Text automatically wraps to the next line when it reaches the right-hand margin, but note that unlike PipeDream the Diary does not reformat the remaining text on the page. This is to avoid altering the layout of any subsequent diary entries on the same page.

The `[ESC]` key can be used to escape from any menu option.

If you call the Calendar from within the Diary, you can use the cursor keys to select a new date. Pressing `[ESC]` then returns you to the Diary which will now display the page for the new date selected. (See **Using the Calendar and Diary together**, p. 68, for details.)

Similarly, if you call the Alarm popdown from the Diary, the date will initially be set to the current date in the Diary. When you return to the Diary, however, the same date will be displayed on the screen as before the Alarm was called.

### Memory low warning

When memory is low, a warning is displayed in the `DIARY DATE` window. You should then free memory before proceeding by deleting obsolete diary entries with the `␣[DEL]` command.

---

# Operations on a block of text – BLOCKS

---

|                                                   |                                                                  |                                      |                                                   |                              |                                                                                   |           |
|---------------------------------------------------|------------------------------------------------------------------|--------------------------------------|---------------------------------------------------|------------------------------|-----------------------------------------------------------------------------------|-----------|
| DIARY<br><b>BLOCKS</b><br>CURSOR<br>EDIT<br>FILES | Mark Block<br>Clear Mark<br>Copy<br>Move<br>Delete<br>List/Print | ◇Z<br>◇Q<br>◇BC<br>◇BM<br>◇ED<br>◇BL | Search<br>Replace<br>Next Match<br>Previous Match | ◇BSE<br>◇BRP<br>◇BNM<br>◇BPM | <b>MENU</b><br>ADVANCE<br>← → ↵ ↶ ↷<br>SELECT<br>ENTER<br>ACTION<br>ESC<br>RESUME | <b>OZ</b> |
|---------------------------------------------------|------------------------------------------------------------------|--------------------------------------|---------------------------------------------------|------------------------------|-----------------------------------------------------------------------------------|-----------|

The commands on the **BLOCKS** menu allow you to perform a command on a block of text with a single operation. A marked block can consist of a single line, can include several lines within one day, or can extend over several days, months, or even years.

To mark a block give the **Mark Block** command on a line to be selected, or at the top and bottom of an area to be selected. The marked block will be displayed highlighted on the screen.

## **Mark Block – ◇Z**

Marks a line, or the first and last lines in a block of lines, prior to performing one of the block operations on the entire block.

## **Clear Mark – ◇Q**

Clears any marked block previously set up with the **Mark Block** command.

## **Copy – ◇BC**

Makes a second copy of all the text within a marked block, putting the copy on the day indicated by the cursor position.

## **Move – ◇BM**

Moves a marked block of text from one position in the Diary to the position indicated by the cursor.

**Delete – ◇BD**

Deletes a marked block of text from the Diary, closing up the gap. Note that this text cannot be recovered – the command should be used with caution.

**List – ◇BL**

Lists all or part of the diary to the screen, or to a printer.

The following options are displayed:

|                        |     |
|------------------------|-----|
| List on screen         | Yes |
| List on printer        | No  |
| List only marked block | Yes |

Pressing **[ENTER]** will list the entire Diary to the screen.

To list part of the Diary, mark the part you wish to list with the **Mark Block** command on the **BLOCKS** menu first.

When listing to the screen the Diary will pause at the end of each screenful with the **PAGE WAIT** display:

```

SPACE
CONTINUE
ESC
RESUME

```

Press the space bar to continue the listing or **[ESC]** to exit.

**Searching and replacing**

The **Search** and **Replace** commands allow you to search for information anywhere in the diary and, if you wish, replace it throughout by different text.

Whenever the Diary is performing a time-consuming task, such as searching through a huge amount of information, or performing a large number of replacements, the cursor will disappear.

**Search – ◇BSE**

Searches for a specified string, and moves to the day containing the first occurrence. You can restrict the search to a marked block, and also print or list all the lines which match the search string.

The following options are displayed:

```

----- STRING TO SEARCH FOR -----

EQUATE UPPER AND LOWER CASE ..... Yes
SEARCH ONLY MARKED BLOCK ..... No
PRODUCE LIST ..... No
PRINT LIST ..... No

```

For example, if you identify every expense claim in your diary with the prefix 'EX:', you could search for or print out all the expenses by entering EX: as the string to search for.

*Equate upper and lower case:* by default the case is ignored so that specifying the will find The THE, etc. Change to **No** to find only strings that match the case of the specified string exactly.

*Search only marked block:* change to **Yes** to restrict the search to a marked block.

*Produce list / Print list:* change to **Yes** to produce a list of the found strings to the screen or printer respectively. This is useful for finding and printing all lines beginning with the same word, such as Meeting.

#### **Next Match – ⌘BNM**

Moves from the cursor position to the next occurrence of the string you are searching for.

#### **Previous Match – ⌘BPM**

Moves from the cursor position to the previous occurrence of the string you are searching for.

#### **Replace – ⌘BRP**

Allows you to replace each occurrence of a string you are searching for with other specified text. By default the case of the replaced string is altered to match the case of the string matched, and before each replacement you are asked whether you want to make it. You can restrict the replacements to a marked block.

Gives the prompts:

```
----- STRING TO SEARCH FOR -----  
----- STRING TO REPLACE WITH -----  
  
EQUATE UPPER AND LOWER CASE ..... Yes  
ASK FOR CONFIRMATION ..... Yes  
SEARCH ONLY MARKED BLOCK ..... No
```

*Replace with:* specifies the string to replace every occurrence of the string to search for.

*Equate upper & lower case:* only affects the search part of the string, and the string is replaced exactly as specified.

The other options operate in the same way as for the **Search** command.

# Moving around the Diary – CURSOR

|               |                  |              |               |         |                     |            |              |           |
|---------------|------------------|--------------|---------------|---------|---------------------|------------|--------------|-----------|
| DIARY         | End of Line      | ◊↔           | Next Word     | SHIFT ↔ | TAB                 | <b>TAB</b> | <b>MENU</b>  | <b>OZ</b> |
| BLOCKS        | Start of Line    | ◊↔           | Previous Word | SHIFT ↔ | Today               | ◊CT        | ADVANCE      |           |
| <b>CURSOR</b> | Last Line        | ◊↔           | Screen Up     | SHIFT ↕ | First Active Day    | ◊CFAD      | ↔ ↕ ↕ ↕      |           |
| EDIT          | First Line       | ◊↔           | Screen Down   | SHIFT ↕ | Last Active Day     | ◊CLAD      | SELECT       |           |
| FILES         | Save Position    | ◊CSP         | Cursor Right  | ↔       | Next Active Day     | ◊↔         | <b>ENTER</b> |           |
|               | Restore Position | ◊CRP         | Cursor Left   | ↔       | Previous Active Day | ◊↔         | ACTION       |           |
|               | ENTER            | <b>ENTER</b> | Cursor Up     | ↕       | Previous Day        | ◊↕         | <b>ESC</b>   |           |
|               |                  |              | Cursor Down   | ↕       | Next Day            | ◊↕         | RESUME       |           |

The commands on the cursor menu enable you to move the cursor to any position on the page of information for the current day in the diary, and to the next or previous day.

## TAB – **TAB**

Inserts spaces to position the cursor at the next tab position to the right. There are preset tab positions preset every 8 characters across the line.

## ENTER – **ENTER**

Moves the cursor to the beginning of the next line.

## Save Position – ◊CSP

Saves the current cursor position. If you move to a new position, you can jump back to the previous position with the **Restore Position** command. Up to five positions can be saved, and they will be restored in turn.

## Restore Position – ◊CRP

Moves the cursor to the last position saved.

---

**Moving within a line****Cursor Right** – ⇨

Moves the cursor one character space to the right.

**Cursor Left** – ⇩

Moves the cursor one character position to the left. You cannot move past the beginning of the line.

**Next Word** – **SHIFT** ⇨

Moves the cursor to the beginning of the next word on the current line.

**Previous Word** – **SHIFT** ⇩

Moves the cursor to the beginning of the previous word on the current line.

**End of Line** – ⇨⇩

Moves the cursor to the character position after the last character on the current line.

**Start of Line** – ⇨⇩

Moves the cursor to the first character position in the current line.

---

**Moving within a day****Cursor Down** – ⇩

Moves the cursor down within the current day.

**Cursor Up** – ⇧

Moves the cursor up within the current day

**Last Line** – ⇨⇩

Moves the cursor to the last line on the current page.

**First Line** – ⇨⇧

Moves the cursor to the first line on the current page.

**Screen Down** – **SHIFT** ↓

Moves the cursor down by a screenful of information.

**Screen Up** – **SHIFT** ↑

Moves the cursor up by a screenful of information.

## Moving between days

**Today** – **CT**

Moves the cursor to today.

**Next Day** – □ ↓

Moves to the next day.

**Previous day** – □ ↑

Moves to the previous day.

## Active days

Days in the Diary which contain information are referred to as 'active' days. You can move rapidly between the active days with the **Next** and **Previous Active Day** commands, and you can find the latest and earliest information in the Diary with the **Last** and **First Active Day** commands.

If you call the Calendar from the Diary, active days, and the day you are currently looking at, are indicated by a marker against the day:

14   **▶**15   16

**Next Active Day** – □ ⇨

Moves to the next day containing an entry.

**Previous Active Day** – □ ⇩

Moves to the previous day containing an entry.

**Last Active Day** – **CLAD**

Moves to the latest day containing any information.



**First Active Day – ◊CFAD**

Moves to the earliest day containing any information.

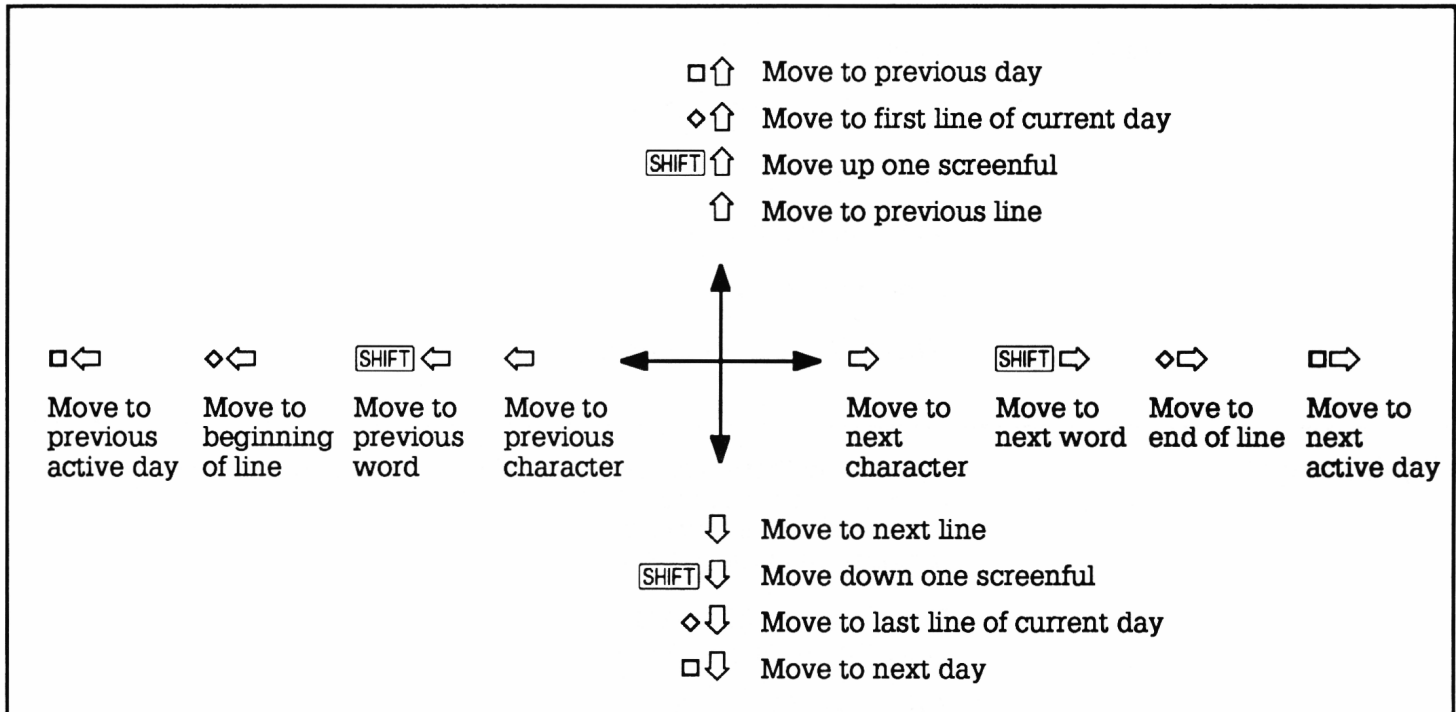
**Summary of Diary cursor operations**

---

# Editing the Diary – EDIT

---

|                                                                               |                                                                                                                      |                                                |                                                            |                        |                          |              |                                                                                               |           |
|-------------------------------------------------------------------------------|----------------------------------------------------------------------------------------------------------------------|------------------------------------------------|------------------------------------------------------------|------------------------|--------------------------|--------------|-----------------------------------------------------------------------------------------------|-----------|
| <b>DIARY</b><br><b>BLOCKS</b><br><b>CURSOR</b><br><b>EDIT</b><br><b>FILES</b> | Rubout<br>Delete Character<br>Insert Character<br>Delete Word<br>Delete to End of Line<br>Delete Line<br>Insert Line | <b>DEL</b><br>◊G<br>◊U<br>◊I<br>◊D<br>◊V<br>◊N | Insert/Overtype<br>Swap Case<br>Next Option<br>Memory Free | ◊U<br>◊S<br>◊J<br>◊EMF | Split Line<br>Join Lines | ◊ESL<br>◊EJL | <b>MENU</b><br>ADVANCE<br>← → ↓ ↑<br>SELECT<br><b>ENTER</b><br>ACTION<br><b>ESC</b><br>RESUME | <b>OZ</b> |
|-------------------------------------------------------------------------------|----------------------------------------------------------------------------------------------------------------------|------------------------------------------------|------------------------------------------------------------|------------------------|--------------------------|--------------|-----------------------------------------------------------------------------------------------|-----------|

---

## Editing within a line

### Insert/Overtype – ◊V

Switches the text entry mode between Insert mode, in which characters typed are inserted at the cursor position, and Overtyping mode, in which characters type over the previous contents of the line.

The current mode is displayed at the right-hand side of the screen in the **DIARY DATE** window.

### Delete Character – ◊G or **SHIFT** **DEL**

Deletes the character at the cursor position. All characters to the right of the cursor will move one position to the left to close up the gap.

### Delete to End of Line – ◊D

Deletes the text from the cursor position to the end of the line.

### Delete Word – ◊T

Deletes all characters from the cursor position to the beginning of the next word. If you position the cursor at the beginning of a word before giving this command, it will delete the word.

### Rubout – **DEL**

Deletes to the left. In Insert mode all characters at and to the right of the cursor will move left.

---

**Insert Character – ◇U**

Inserts a blank space at the cursor position.

**Swap Case – ◇S**

Changes the case of the character at the cursor position and moves the cursor to the next character.

---

**Editing within a day****Delete Line – ◇Y or ◇DEL**

Deletes the current line. Text on subsequent lines is moved up one line to close up the gap.

**Join Lines – ◇EJL**

Adds the text on the next line to the end of the text on the current line.

**Insert Line – ◇N**

Inserts a blank line at the cursor position. The text on the current line and all subsequent lines is moved down one line.

**Split Line – ◇ESL**

Splits the current line at the cursor position. All characters at, and to the right of the cursor, will be moved to the next line.

---

**Miscellaneous****Memory Free – ◇EMF**

Displays the amount of space available, in bytes, in the **DIARY DATE** window on the right-hand side of the Diary screen. Each byte represents the space needed for a character; approximately 2000 bytes are needed to store a typical A4 page of text.

**Next Option – ◇J**

Alternates between the available values of an option.

---

# Loading and saving – FILES

---

|                                            |              |            |  |                                                                          |    |
|--------------------------------------------|--------------|------------|--|--------------------------------------------------------------------------|----|
| DIARY<br>BLOCKS<br>CURSOR<br>EDIT<br>FILES | Load<br>Save | ◊FL<br>◊FS |  | MENU<br>ADVANCE<br>← → ↓ ↑<br>SELECT<br>FILES<br>ACTION<br>ESC<br>RESUME | OZ |
|--------------------------------------------|--------------|------------|--|--------------------------------------------------------------------------|----|

The commands on the **FILES** menu allow you archive old information in the Diary, or to load a range of entries into the Diary, starting at a different date (such as a year later).

## Load – ◊FL

Incorporates a diary file of a specified name into the information currently in the Diary.

Gives the prompts:

----- NAME OF FILE TO LOAD -----

START LOADING DATA AT DIARY DATE ..... No

A block of Diary entries can be copied from one range of dates to another, such as from one year to the next, by saving the block, moving to the same date in the next year (using the Calendar), and then loading the data back with the option set

START LOADING DATA AT DIARY DATE ..... Yes

Because loading appends data to whatever is already in the diary, an additional blank line will be present on the current day after a load.

Instead of typing the file name, the file can be selected from the Filer. After typing ◊FL call the Filer by typing ◻F, and select the required file by marking it (see **Selecting files**, p. 83). When you return to the Diary from the Filer by pressing [ESC] the selected file name will have been

copied to the **Load** window. You will then just need to press **ENTER** to load the file.

### Save – **◇FS**

Saves the Diary to the current name, or to a name you specify. Normally the whole diary is saved. You can also save part of the Diary by marking the block of text first.

Gives the prompts:

----- NAME OF FILE TO SAVE -----

SAVE ONLY MARKED BLOCK ..... No



---

## Section Seven **Filer reference**

---

This section describes the more advanced features of the Filer popdown, and should be read in conjunction with the Filer description in Section Three. The features described here include:

- Directories, and the hierarchical filing system
- The Command Line Interpreter, and CLI files

---

### **Specifying file names in full**

The full form of a file name is

*:DEVICE/DIRECTORY/DIRECTORY/ ... /filename*

where *DIRECTORY* and *filename* are each of the form  
*name.extension*

consisting of a *name* of up to 12 letters or digits, followed by an optional *extension* of up to three letters or digits,

The following extensions are used for system functions:

|      |                                              |
|------|----------------------------------------------|
| .sgn | For □+K and □+S CLI files                    |
| .CLI | For BOOT.CLI; see <b>CLI files</b> , p. 179. |
| .L   | For PipeDream multi-file List file           |

*DIRECTORY* is a directory name subject to the same constraints as *filename*.

In addition the following symbols can be used:

|                |                                 |
|----------------|---------------------------------|
| <i>../name</i> | Parent directory of <i>name</i> |
| <i>.</i>       | Current directory               |

## Device specifications

*DEVICE* can be specified as one of the following:

| Specification | Effect                                                                                |
|---------------|---------------------------------------------------------------------------------------|
| :RAM.0        | RAM in slot 0 (internal memory)                                                       |
| :RAM.1        | RAM in slot 1 (external memory)                                                       |
| :RAM.2        | RAM in slot 2 (external memory)                                                       |
| :RAM.3        | RAM in slot 3 (external memory)                                                       |
| :RAM.-        | Any RAM memory; ie 0, 1, 2, or 3. Used by CLI for temporary files, and lost on reset. |
| :ROM.0        | ROM                                                                                   |
| :SCR.0        | Screen                                                                                |
| :PRT.0        | Printer; via printer driver so that highlight codes are interpreted                   |
| :COM.0        | Communications; via serial port                                                       |
| :INP.0        | Standard input                                                                        |
| :OUT.0        | Standard output                                                                       |
| :NUL.0        | Null: absorbs output, and acts like an empty file on input                            |

**Note:** RAM.- files must be deleted before a soft reset is performed with Operating Systems up to and including 3.0.

## Wildcards

The device, directory and file name can contain the following wildcards:

|    |                                             |
|----|---------------------------------------------|
| *  | Matches any number of characters (or none)  |
| ?  | Matches a single character                  |
| // | Matches any number of directories (or none) |

For example,

|            |                                                                           |
|------------|---------------------------------------------------------------------------|
| :*//letter | Finds the file called <b>letter</b> anywhere                              |
| doc*       | Finds: <b>doc.tx</b> , <b>document</b> , <b>doc27</b> , <b>doc</b> , etc. |
| *.*        | Finds only files with extensions.                                         |
| ../fred*   | Finds all files beginning with <b>fred</b> in the parent directory        |

Note that the characters '/' and '\' may be used interchangeably.



**Additional Filer commands**

The following commands provide facilities for creating directories, manipulating files within the hierarchical directory structure, and executing files of commands. The files referenced by commands such as **Select directory** or **Execute** can be selected by marking them; see **Selecting files**, p.83.

|                           |                   |                    |                  |         |                  |     |              |           |
|---------------------------|-------------------|--------------------|------------------|---------|------------------|-----|--------------|-----------|
| <b>FILER<br/>COMMANDS</b> | Catalogue Files   | ◇CF                | Create Directory | ◇CD     | Catalogue EPROM  | ◇CE | <b>MENU</b>  | <b>OZ</b> |
|                           | Copy              | ◇CO                | Select Directory | ◇SI     | Save to EPROM    | ◇ES | ADVANCE      |           |
|                           | Rename            | ◇RE                | Up Directory     | SHIFT ↵ | Fetch from EPROM | ◇EF | ↵ ↵ ↵ ↵      |           |
|                           | Erase             | ◇ER                | Down Directory   | SHIFT ↵ | Select Device    | ◇SU | SELECT       |           |
|                           | Execute           | ◇EX                | Cursor Right     | ↵       | Tree Copy        | ◇TC | <b>ENTER</b> |           |
|                           | Select First File | <b>ENTER</b>       | Cursor Left      | ↵       | Name Match       | ◇NM | ACTION       |           |
|                           | Select Extra File | SHIFT <b>ENTER</b> | Cursor Up        | ↵       |                  |     | <b>ESC</b>   |           |
|                           |                   |                    | Cursor Down      | ↵       |                  |     | RESUME       |           |

**Select Directory – ◇SI**

Sets the current directory to the specified directory. Gives the prompt

Name : █

displaying the current directory string (if any).

For example, to set the current directory to directory TEXT in the current directory, specify

Name : TEXT

If the directory has not been created, a **File not found** error will be displayed.

**Select Device – ◇SV**

Sets the current device. Gives a prompt such as

Name : :RAM.0

showing the current device, which can be edited to the required new device.

The **Select Device** command resets the current directory to the root directory.

The **Select Device** and **Select Directory** commands affect the device and directory for the activity from which the Filer was entered, if there is

one. This allows different activities to use different devices and directories without the need for specifying them explicitly each time.

Note, therefore, that if you save files having set a device and/or directory from one activity, and then enter the Filer from another activity, the files may not appear in the DIRECTORY list. Check the directory displayed at the top of the DIRECTORY window to ensure that you are in the intended directory.

**Down Directory** – **[SHIFT]** ↓

**Up Directory** – **[SHIFT]** ↑

These commands are used for traversing a hierarchical directory structure. To select a directory move the highlight bar to the directory name in the Filer DIRECTORY window and press **[SHIFT]** ↓. To go back up to the parent directory press **[SHIFT]** ↑.

**Execute** – **◇EX**

Executes a CLI file of commands specified after the prompt

**Name** : ■

See **CLI files** below.

**Create Directory** – **◇CD**

Creates a directory within the current directory; the name is specified after the prompt

**Name** : ■

**Tree Copy** – **◇TC**

Copies a file tree from one directory to another. Arguments to the **Source** and **Destination** fields must be devices or directories. For example,

```
Source : :RAM.1
Destination : :RAM.2
```

will make a duplicate copy of all files from RAM card 1 to RAM card 2.

The source area cannot be part of the destination area.

**Name Match – ◊NM**

Sets up a match string restricting access to files in the current directory to those that match the string. For example, setting

```
Name : *.bas
```

will catalogue only files with a `bas` extension. The default match string is `*`, matching all file names. When a name match other than `*` is active, the symbol `NM` will be displayed at the left-hand end of the Filer DIRECTORY window.

**CLI files**

The Filer **Execute** command, ◊EX, allows a text file to be passed to the Command Line Interpreter, or CLI. The effect is as if the characters in the file had been typed at the Z88 keyboard. CLI files thus provide a means of specifying a sequence of commands or operations, which can then be carried out simply by executing the file. For example, an execute file could be used to carry out a frequently-used sequence of Replace operations in PipeDream documents.

Certain characters are given a special significance in CLI files, to allow special keys on the keyboard to be represented, or additional operations to be carried out by the Command Line Interpreter.













These special characters, and their functions, are as follows:

```
#       Prefixes a □ key sequence
!       Prefixes a ◊ key sequence
~       Used in combination with a letter to represent other special keys
        on the Z88 keyboard
.       As the first character on a line, introduces a special CLI
        command.
```

To represent these actual characters in a command file, they should be specified twice:

| Sequence | Represents |
|----------|------------|
| ##       | #          |
| ~~       | ~          |
| !!       | !          |

### Key sequences

| Character | Significance                                                                      |
|-----------|-----------------------------------------------------------------------------------|
| ~A        | Single press of the $\square$ key; ~A~A has no effect                             |
| ~C        | Single press of the $\diamond$ key; ~C~C has no effect                            |
| ~S        |  |
| ~I        |  |
| ~M        |  |
| ~H        |  |
| ~E        |  |
| ~X        |  |
| ~T        |  |
| ~U        |  |
| ~D        |  |
| ~L        |  |
| ~R        |  |
| ! [       |  |

### File control commands

The full-stop character introduces the following special commands when it is the first character of a line in an execute file.

| Sequence     | Significance                                                     |
|--------------|------------------------------------------------------------------|
| .T> filename | Create output file                                               |
| .T< filename | Create input file                                                |
| .T= filename | Create printer file                                              |
| .> filename  | Redirect output                                                  |
| .< filename  | Redirect input                                                   |
| .= filename  | Redirect printer                                                 |
| .D nnn       | Delay nnn centiseconds                                           |
| .S           | Suspend CLI; all redirections of input or output remain in force |
| .* filename  | Invoke new file to CLI                                           |
| .J           | Ignore special significance of subsequent escape characters      |
| .; a comment | Ignored.                                                         |

The T character represents a 'T' junction, as it causes an additional copy of the input or output to be sent to a specified stream. For example:

```
.T>:RAM.0/fred.txt
```

sends a copy of what is going to the screen to the file

```
:RAM.0/fred.txt
```

The J character stands for 'Jam', as it inhibits interpretation of the escape characters.

Printer output can be spooled to a file with the '=' symbol. For example,

```
.= :RAM.0/printout
```

takes the text that would have been printed out, before printer codes are added, and puts the text into the file

```
:RAM.0/printout
```

### Terminating execute files

When the CLI is running an execute file a CLI symbol is displayed in the OZ area of the screen. The current CLI can be terminated by pressing **SHIFT ESC**. If several CLIs are running they can all be terminated by holding down **◇** and pressing **ESC**.

### Redirecting keyboard input and screen output

The following key combinations can be used to redirect keyboard input and screen output:

| Key | Effect                                               |
|-----|------------------------------------------------------|
| □+P | All screen output also sent to the printer           |
| □+S | All screen output also sent to the file :RAM.-/S.sgn |
| □+K | Key input also sent to the file :RAM.-/K.sgn         |

For example, □+P can be used to obtain a catalogue of EPROM or RAM to a printer.

The corresponding sequences with '-' turn the facility off, and sequences □+P and □+S are mutually exclusive.

The commands □+S and □+K generate files K.sgn and S.sgn in temporary RAM. These should be deleted after use with the Filer **Erase** command.

### Editing BASIC programs using PipeDream

BASIC programs are saved in a tokenised format, and so cannot be loaded into PipeDream and edited directly. However, the CLI provides a convenient way of obtaining a text listing of a BASIC program, which can then be edited and executed back into BASIC.

The procedure is as follows:

- ① LIST the program to the file :RAM.-/S.sgn by typing

```
LIST □+S 
```

- ② When the listing has finished, close the file by typing

```
□-S
```

The file :RAM.-/S.sgn can be loaded into PipeDream as plain text, and edited.

- ③ Add the characters

```
.J  
NEW
```

at the start of the file, and save it from PipeDream using the *Plain text* option.

- ④ Execute the edited file back into BASIC by entering BASIC and typing:

```
*CLI .*FILENAME
```

to invoke the CLI to execute the file.

- ⑤ When finished, erase the file :RAM.-/S.sgn using the Filer.

The .J at the start of the file avoids the need to replace characters such as # by ## throughout the BASIC program so that they will not be interpreted by the CLI.

**Executing a file on reset**

On resetting the Z88, if a file with the name

BOOT.CLI

exists on an EPROM card in slot 3, it will be copied into

:RAM.-/BOOT.CLI

and then executed. The file should be deleted when it is no longer required.





---

# Section Eight    **The Terminal**

---

The Terminal application provides a widely-used VT52 standard for communicating between a Z88 and another computer, or between two Z88 computers, over the RS232 serial line.

The Terminal can be entered from the Index APPLICATIONS menu, or by typing □V. You can leave the Terminal by pressing the [SHIFT] and [ENTER] keys together.

### Serial port settings

The serial port parameters can be configured from the panel which is entered with □S; see **Panel options**, p. 87.

---

### Control keys

The equivalent Z88 keys for the VT52 control keys are shown in the following table, together with a list of the codes transmitted:

| VT52      | Z88          | Codes sent |
|-----------|--------------|------------|
| DELETE    | [DEL]        | \$7F       |
| BACKSPACE | [SHIFT][DEL] | \$08       |
| UP        | ↑            | ESC A      |
| DOWN      | ↓            | ESC B      |
| RIGHT     | →            | ESC C      |
| LEFT      | ←            | ESC D      |
| F0        | [SHIFT] ←    | ESC P      |
| F1        | [SHIFT] →    | ESC Q      |
| F2        | [SHIFT] ↓    | ESC R      |
| F3        | [SHIFT] ↑    | ESC S      |
| CONTROL   | ◇            | -          |

These functions are provided on the Terminal **COMMANDS** menu, with the following additional command:

**Exit** - [SHIFT][ENTER]

Removes the terminal and returns to the Index.

From the Index, ◇KILL is preferred.

---

## Spooling files

Material received by the Terminal application can be spooled to a file :RAM.-/S.sgn automatically by typing `□+S` before commencing the transfer. The file will be created in temporary RAM, and should be deleted after use.

Spooling can be disabled by typing `□-S`.

---

## Transmitting files

A convenient way of sending a file to a remote machine is to copy the file to the :COM device.

Enter the Terminal and establish contact with the remote machine in the usual way, and then type `□F` to go into the Filer.

Select the file you wish to transmit and then choose **Copy** from the Filer menu (see pp. 83-85 for details of how to select and copy files). A dialogue box will appear. Type in :COM as the destination and press `[ENTER]`. The file will then be transmitted.

Once the transmission is over the dialogue box will disappear leaving the Filer display on the screen. You may then press `[ESC]` to return to the Terminal.

---

## Section Nine

# The Printer Editor

---

With PipeDream you can create documents containing highlight codes that specify particular type styles and effects, such as bold and underlined text, superscripts and subscripts, and alternative fonts. Because different printers use different techniques to achieve these effects, the Z88 uses a printer driver to convert the standard PipeDream highlights to each particular printer's codes. The printer driver can then be altered to suit a particular printer's facilities.

The Z88 comes with a built-in driver, which interfaces with the widely-used Epson series of dot-matrix printers, or other printers compatible with this.

### Creating a new printer driver

The Z88 PrinterEd application allows you to create your own printer driver definition, editing the options used by the built-in driver to add your own special printing effects to your documents.

Alternatively, you can design a printer driver definition for a make of printer not catered for by the built-in driver. To do this you will need to consult the printer handbook, to find out which codes are needed for each facility you want to use.

Having created a new printer driver definition, you can use this to replace the built-in driver with the **Update Driver** command.

To run the editor select PrinterEd from the Index APPLICATIONS list, or press  $\square$ E from any application.

The driver definition is displayed on two pages. You can move between the pages with the following commands:

$\square$ SHIFT  $\downarrow$   
 $\square$ SHIFT  $\uparrow$

move from page 1 to page 2  
move from page 2 to page 1.

While developing and testing a printer driver it is sensible to keep PrinterEd as a suspended activity. On completing a driver definition, and saving it to the filing system, the PrinterEd activity can be deleted from the Index with  $\diamond$ KILL.

## Editing the driver definition

The printer driver definition is altered by moving the cursor to the appropriate field on the page with the cursor keys,  $\uparrow$ ,  $\downarrow$ ,  $\leftarrow$ , or  $\rightarrow$ , and then typing the required value for the option. The editing commands are summarised on the PrinterEd **CURSOR** menu.

Some options take a Yes/No value; in this case you can toggle between the values with the **Next Option** command,  $\diamond J$ , or select the appropriate value by typing Y or N.

Most options take a list of one or more codes, separated by commas.

### Code values

Printer codes can be entered in any of the following forms:

| Type               | Example 1 | Example 2 |
|--------------------|-----------|-----------|
| Decimal number     | 90        | 27        |
| Hexadecimal number | \$5A      | \$1B      |
| ASCII character    | "Z"       |           |
| ASCII symbol       |           | ESC       |

The two examples show equivalent representations of the same values.

Any of the standard ASCII symbols can be used to represent the values 0 to 31, or \$0 to \$1F. A full list is given in **Appendix D – Z88 Character Set**.

## Highlight codes

Page 1 of the PrinterEd application allows the behaviour of each of the eight PipeDream highlight codes to be specified.

|                             |                   |   |               |              |          |        |          |     |     |           |
|-----------------------------|-------------------|---|---------------|--------------|----------|--------|----------|-----|-----|-----------|
| PRINTERE<br>CURSOR<br>FILES | PRINTER<br>EDITOR | 1 | ON            | Underline    | 27,45,1  | OFF    | 27,45,0  | Off | Yes | <b>OZ</b> |
|                             |                   | 2 | String        | Bold         | 27,69    | String | 27,70    | at  | Yes |           |
|                             |                   | 3 | Ext. sequence | Italics      | 27,52    |        | 27,53    | CR  | Yes |           |
|                             | PRINTER           | 4 |               | Subscript    | 27,83,1  |        | 27,84    |     | Yes |           |
|                             | Epson             | 5 |               | Superscript  | 27,83,0  |        | 27,84    |     | Yes |           |
|                             | Page 1            | 6 |               | Alt. font    | 15       |        | 18       |     | No  |           |
|                             | Page 2: SHIFT     | 7 |               | User defined | 27,120,1 |        | 27,120,0 |     | No  |           |
|                             |                   | 8 |               |              |          |        |          |     |     |           |

The recommended assignment of highlight codes to printer functions is as follows:

| Code | Function          | Printed example        |
|------|-------------------|------------------------|
| 1    | Underline         | <u>underlined type</u> |
| 2    | Bold              | <b>bold type</b>       |
| 3    | Extended sequence | é ç π                  |
| 4    | Italic            | <i>italic type</i>     |
| 5    | Subscript         | H <sub>2</sub> O       |
| 6    | Superscript       | e=mc <sup>2</sup>      |
| 7    | Alternative font  | alternative font       |
| 8    | User defined      |                        |

In every case the same highlight turns the facility off, and in all cases except 7 and 8, the facility is also turned off at the end of a slot.

The highlight table contains three columns specifying the following information for each of the eight highlights, 1 to 8:

- ON String**      The sequence of codes needed to turn the facility on
- OFF String**     The sequence of codes needed to turn the facility off
- Off at CR**      Y~~e~~ or N~~o~~, to determine whether the facility should be cancelled at the end of a slot.

You can move between columns using the cursor keys ← and →, and between lines with ↑ and ↓.

### ON String and OFF String

The ON String specifies the sequence of codes to turn the corresponding printer facility on, and the OFF String the sequence of codes to turn it off. Each of these sequences of codes is output on alternate occurrences of the specified highlight code in the document.

If the facility is toggled on and off by the same sequence of codes, the OFF String can be omitted, and the ON String will be output on every occurrence of the highlight.

### Overprinting

On some printers special effects can be obtained by outputting a sequence of codes for every character printed. For example, some daisy-wheel printers underline by backspacing, and then printing an underscore character, for every character printed.

You can set up highlights that work on this principle by including the special '?' character in the ON String. When the highlight is active, the specified ON String sequence will be output for every character printed, with '?' replaced by that character. This facility is toggled on and off by successive occurrences of the specified highlight code.

For example, to underline by backspacing and overprinting an underscore character, give the sequence

```
1      ON   Underline ?,BS,"_"
```

If '?' occurs in the ON String the OFF String is ignored, and should be left blank.

### Off at CR

The final column specifies for each code whether the facility should be turned off automatically at the end of each slot. In general, all highlights which are normally inserted on a word by word basis, such as underlining and bold type, should specify **Yes** (the default) in this column.

Off at CR should also be set to **Yes** if the printer itself turns off the corresponding facility at a carriage return.

Off at CR should be set to **No** in the case of highlights, such as alternative font, which are applied to a large section of a document. Note that in this case headers and footers within the highlighted area will also be affected.

## Printer options

Page 2 of the PrinterEd application allows the driver definition options to be specified, and up to nine character translations to be set up.

|                                   |                                                                                                  |                                                                                                             |                                                                                                            |                                      |
|-----------------------------------|--------------------------------------------------------------------------------------------------|-------------------------------------------------------------------------------------------------------------|------------------------------------------------------------------------------------------------------------|--------------------------------------|
| <b>PRINTED</b><br>CURSOR<br>FILES | <b>PRINTER CODE</b><br><b>EDITOR</b><br><br><b>PRINTER</b><br>Epson<br>Page 2<br>Page 1: SHIFT ↑ | Printer on 27,64<br>Printer off<br>End of page 12<br>Allow line feed Yes<br>HMI: Prefix<br>Suffix<br>Offset | Translations<br>Character 163<br>Changes to 27,82,3,<br>Character<br>Changes to<br>Character<br>Changes to | <b>A</b> <b>E</b> <b>C</b> <b>OZ</b> |
|-----------------------------------|--------------------------------------------------------------------------------------------------|-------------------------------------------------------------------------------------------------------------|------------------------------------------------------------------------------------------------------------|--------------------------------------|

### Printer on

Specifies a sequence of codes to be sent to the printer before printing a document. For example, the codes 27,64 in the Epson driver definition initialise the printer.

### Printer off

Can be used to reset the printer to its previous settings so that subsequent printing will not be affected.

### End of page

Specifies a sequence of codes to be sent to the printer at the end of each page. If the sequence contains a form-feed character, 12 (or FF), PipeDream will not output linefeeds to the end of page, resulting in faster and quieter page ejects on printers that support this.

### Allow line feed

Determines whether a line feed code (LF) is sent at the end of each line, in addition to a carriage return (CR). This option is set to **Yes** in the default Epson driver. If unwanted extra line feeds are produced, so that all printing is double-spaced, change the option value to **No**.

*Note:* With Operating Systems 3.0 and earlier, selecting **No** will cause ASCII 0 (NULL) to be sent instead of ASCII 10 (LF).

### Microspacing – HMI

Certain printers allow the horizontal movement of the print head to be controlled to 1/120th of an inch, which means that text will be justified

with an almost perfectly even distribution of the space. The following sample is printed without microspacing:

This sample of text demonstrates the improvement gained by justifying text with microspacing.

The same sample with microspacing is shown below:

This sample of text demonstrates the improvement gained by justifying text with microspacing.

Microspacing requires a Horizontal Motion Increment, or HMI, to be specified to the printer as the number of 120ths of an inch to be allocated to the printing of subsequent characters. This is normally given after a prefix code, although for some printers a suffix is also required. For example, the Ricoh, Flowriter 1600, and JUKI 6100 use the following prefix:

```
HMI prefix ESC,31
HMI suffix
HMI offset 1
```

### Translations

The character translation table allows up to 9 single-character substitutions to be made before printing, so that alterations can be made to the character set supplied by the printer. The sequence may include a string of codes, which will scroll within the window as they are entered.

For example, the default Epson driver uses the following sequence to print a '£' sign, assuming it is set up to use the USA character set:

```
27,82,3,35,27,82,0
```

which is equivalent to:

```
ESC,"R",3   select UK character set
35          print pound sign
ESC,"R",0   restore USA character set
```



## PrinterEd FILES menu

The PrinterEd **FILES** menu provides commands to allow driver definitions to be used for subsequent printing, or to be saved and loaded as named files. You can also reset the driver definition to the standard Epson driver.

|                                     |                                              |                                   |                                                                          |           |
|-------------------------------------|----------------------------------------------|-----------------------------------|--------------------------------------------------------------------------|-----------|
| PRINTERED<br>CURSOR<br><b>FILES</b> | Load<br>Save<br>Name<br>New<br>Update Driver | ◇FL<br>◇FS<br>◇FC<br>◇FNEW<br>◇FU | MENU<br>ADVANCE<br>⬅ ➡ ⬆ ⬇<br>SELECT<br>ENTER<br>ACTION<br>ESC<br>RESUME | <b>OZ</b> |
|-------------------------------------|----------------------------------------------|-----------------------------------|--------------------------------------------------------------------------|-----------|

The name of the current driver definition, initially Epson, is displayed on the Printer Editor screen and is shown for the PrinterEd activity in the Index YOUR REF. column.

### Load – ◇FL

Allows a driver definition to be loaded into the Printer Editor. Gives the prompt:

#### Filename █

Note that the driver definition is not actually installed until the **Update Driver** command is given.

### Save – ◇FS

Saves the current driver definition with a specified name.

### Name – ◇FC

Sets the name of the current driver definition.

### New – ◇FNEW

Resets the driver definition in the Printer Editor to the options for the default Epson driver, and resets the driver used for printing to this driver.

### Update Driver – ◇FU

Creates a printer driver from the definition currently in the Printer Editor, and installs it for use in subsequent printing.



---

## Section Ten

# BBC BASIC

---

PipeDream can be used to carry out most of the operations you are likely to want to perform on text and numbers, such as entering and editing, searching, sorting and calculating. However, some problems would require you to carry out a sequence of different operations and this might be cumbersome and time-consuming using PipeDream. For this sort of problem you can turn to the BBC BASIC programming language which is provided in your Z88.

Programming languages are designed to allow you to instruct the computer to carry out a sequence of operations on text or numbers. BASIC is one such general-purpose programming language, and is the most widely used language on microcomputers. BASIC has a significant advantage over many other languages in that it is interactive: you can make changes to a sequence of instructions, and see the result immediately without having to perform any intervening operations. This means that programs can be developed relatively quickly.

This section provides a reference list of all the Z88 BBC BASIC language keywords. It is not intended as a tutorial on the BASIC language; many excellent books on this subject already exist.

The keywords are divided into four types:

**Commands** are instructions that can be typed from the keyboard to assist in creating a program, and testing it out. Commands are typed from the keyboard in immediate mode after the BASIC > sign prompt, and they may not be used within programs.

**Statements** are the special keywords that are used within programs, after a line number, to instruct the computer to do something. Most statements can also be typed directly after the BASIC prompt, and are then executed immediately so that you can try out their effect.

The BASIC statements are normally the first keyword after the line number in a program line.

**Functions** can be included in expressions, and will return the result of performing an operation on the arguments enclosed in brackets after their name. They are similar to the functions in PipeDream.

A function can be followed by one or more arguments, and returns a number or a string. Functions which take only one argument require brackets around the argument only if it is a complex expression. If the argument is a simple number, variable, or another function, no brackets are required.

Finally, the **operators** can be used to link the components of expressions.

The following keywords, associated with **graphics**, **sound**, and **analogue** operations in other versions of BBC BASIC, give the error

`Sorry, not implemented`

on the Z88:

Graphics: CLG, COLOUR, DRAW, GCOL, MODE, MOVE, PLOT, POINT

Sound: ENVELOPE, SOUND

Analogue: ADVAL

---

## Entering BBC BASIC

You enter BBC BASIC by selecting BASIC from the Index APPLICATIONS LIST, or by typing `QB` from any application. The initial BASIC screen will then be displayed:

```
BASIC      BBC BASIC (Z80) Version 3.00      OZ
             (C) Copyright R.T.Russell 1987
             >|
```

CAPS

In an unexpanded machine, BASIC has a workspace of 8K bytes. In an expanded machine, containing in slot 1 at least 128K RAM, the workspace is increased to 40K.

## Entering keywords

Many keywords may be abbreviated when entered into a program, and will be expanded by the BASIC interpreter. In such cases the shortest abbreviation is shown in brackets after the full form; eg AUTO (AU).

All keywords must be entered in capitals, as shown in the following alphabetical list. **Inverted Caps** mode can be selected by typing   [CAPSLOCK]. To give capital letters when the Z88 keys are typed alone, and lower-case letters when typed with the [SHIFT] key. Press   [CAPSLOCK] to restore ordinary Caps mode.

## Editing BASIC programs

The following program provides BBC BASIC on the Z88 with a line editor. The line editor works as follows:

- ① To edit a line you need to type: `PROCE(line number)`  [ENTER]

The editor will list out the line and put the cursor at the end.

- ② You can now use the cursor keys to move within the line and make changes, and most of the edit commands available in PipeDream such as **Delete Word** etc.
- ③ When you have made all the changes you want, press  [ENTER] to store the line back in the program. If you want to abandon the changes you have made then press  [ESC] and the line will be left unchanged.

Before you can use the editor you must type in the following program. You can then start writing your own program. When you save your program the editor will be saved with it.

```

60000 END
60010 DEF PROCE(B)
60020 REM Cambridge Computer Ltd.
60030 IF B=0 THEN ENDPROC
60040 A=OPENOUT":RAM.0/EE.CLI"
60050 B$=":RAM.0/E.CLI"
60060 PRINT#A,".>" + B$
60070 PRINT#A,".J", "LIST" + STR$(B), "PROCF"
60080 CLOSE#A
60090 *CLI .*:RAM.0/EE.CLI
60100 ENDPROC
60110 DEF PROCF
60120 A=INKEY(0)
60130 A=OPENIN B$
60140 INPUT#A,A$,A$
60150 CLOSE#A
60160 A=OPENOUT B$
60170 PRINT#A,".J",A$
60180 PTR#A=PTR#A-1
60190 BPUT#A,0
60200 CLOSE#A
60210 VDU 8
60220 OSCLI"*CLI .<" + B$
60230 ENDPROC

```

If you have several existing programs which you would like to append the editor to you must type the editor into PipeDream. On the first line you must include the CLI command .J . Now save the file in plain text format as EDBAS. When you want to use the editor start a BASIC and load the program you want to edit. To append the editor onto the end of your program type:

```
*CLI .*EDBAS 
```

where EDBAS should be in the directory selected by this application.

Note that if your program uses line numbers above 60000 you should renumber it first before appending the editor.

The editor generates two working files in :RAM.0 called /EE.CLI and /E.CLI. The files can be erased after use. If you have a RAM card in slot 1 or slot 2 you could alter the program to save its working files in :RAM.1 or :RAM.2 by changing lines: 60040, 60050, and 60090.

## Printing from BASIC

The following program shows how to print from a BASIC program:

```
100 LET PRT_ON$=CHR$(5)+"["
110 LET PRT_OFF$=CHR$(5)+"]"
120 LET LF$=CHR$(10)
130 :
140 LET PRT=OPENOUT":PRT"
150 IF PRT=0 THEN PRINT" CAN'T OPEN PRINTER ":STOP
160 :
170 PRINT#PRT,PRT_ON$
180 FOR I=1 TO 4
190   PRINT#PRT,"Text "+STR$(I*PI)+" and numbers!"+LF$
200 NEXT I
210 PRINT#PRT,PRT_OFF$
220 :
230 CLOSE#PRT
```

When run it prints the following:

```
Text 3.14159265 and numbers!
Text 6.28318531 and numbers!
Text 9.42477796 and numbers!
Text 12.5663706 and numbers!
```

---

# BASIC keywords

---

**ABS Absolute value (function)**

Returns the absolute positive value of its argument.

**ACS Arc cosine (function)**

Returns the arc cosine of its argument in radians. The permitted range of the argument is -1 to +1.

For example,

```
PRINT DEG(ACS(0.5))
```

will print 60, because  $\text{COS}(60^\circ)$  is 0.5.

**AND (A.) Logical AND (operator)**

Performs a bitwise logical AND between two operands which are internally converted to 4 byte integers before the operation.

It is normally used to join two conditions in an IF or UNTIL statement; thus

```
IF length >10 AND width > 10 THEN PRINT "OK"
```

ensures that a rectangle is larger than 10 x 10.

**ASC ASCII value (function)**

Returns the ASCII character value of the first character of the argument string.

```
PRINT ASC("Z88")
```

gives 90, the ASCII value of "Z".

The brackets are optional, and `ASC ""`, the null string, gives -1.

**ASN Arc sine (function)**

Returns the arc sine of its argument in radians. The permitted range of the argument is -1 to +1.

**ATN Arc tangent (function)**

Returns the arc tangent of its argument in radians.

**AUTO (AU.) Automatic numbering (command)**

Allows lines to be entered without first typing in the number of the line. The line numbers are preceded by the usual prompt (>).

By default the starting line number and increment are both 10, but they may optionally be specified; for example

```
AUTO 20
```

will start with line 20, and

```
AUTO 100, 20
```

will start at line 100 and increment by 20. AUTO will continue generating line numbers until you press [ESC].

**BGET# (B.#) Byte from data file (function)**

Returns a byte from the data file whose channel number is its argument. The file pointer is incremented after the byte has been read. For example,

```
character=BGET#c
```

reads the next character from file c.

**BPUT# (BP.#) Output a byte (statement)**

Puts a byte to the data file whose channel number is the first argument. The second argument's least significant byte is written to the file. The file pointer is incremented after the byte has been written. Thus

```
BPUT#channel, char
```

writes char to file channel.



**CALL (CA.) Call machine-code (statement)**

Calls a machine code subroutine at a specified address, passing parameters in a parameter block addressed by the Z80's IX register. The IY register is set to the address of the machine code subroutine being called. The processor's A, B, C, D, E, F, H, and L registers are initialised to the least significant bytes of A%, B%, C%, D%, E%, F%, H%, and L% respectively.

This statement could cause corruption of the Z88 memory, and should therefore only be used by experienced programmers.

The parameter block contains the following list:

|                         |         |                   |
|-------------------------|---------|-------------------|
| number of parameters    | 1 byte  | (IX+0)            |
| first parameter type    | 1 byte  | (IX+1)            |
| first parameter address | 2 bytes | (IX+2,IX+3)       |
| parameter type          | )       | repeated as often |
| parameter address       | )       | as necessary      |

**Parameter types**

|     |                                                              |
|-----|--------------------------------------------------------------|
| 0   | 8 bit bytes (eg ?a)                                          |
| 4   | 32 bit integer variable (eg !b or c%)                        |
| 5   | 40 bit floating point number (eg d)                          |
| 128 | A string at a defined address (eg \$e - terminated by a &0D) |
| 129 | A string variable such as f\$                                |

In the case of a string variable the parameter address is the address of a String Information Block which gives the current length of the string, number of bytes allocated, and start address, in that order.

```
muldiv=1234
CALL muldiv,A,B$,C%
```

**CHAIN (CH.) Load and run program (statement)**

Loads and runs the program whose name is specified in the argument allowing one program to load another. Information can be passed between programs using the static variables @%, and A% to Z%.

**CHR\$ ASCII character (function)**

Returns the ASCII character string specified by the least significant byte of the numeric argument.

```
A$=CHR$(90)
```

will set A\$ to "Z", since ASC"Z" is 90. The characters corresponding to values 32 and above can be displayed on the screen with the line

```
FOR N%=32 TO 255: PRINT CHR$(N%);: NEXT
```

**CLEAR (CL.) Clear program (statement)**

Clears all variables, including strings apart from the static variables @%, and A% to Z%.

**CLOSE# (CL.#) Close channel (statement)**

Closes a specified channel. For example,

```
CLOSE#c
```

closes channel c.

**CLS Clear text area (statement)**

Clears the text area of the screen. The text cursor is moved to the 'home' position (0,0) at the top left-hand character position of the text area.

**COS Cosine (function)**

Returns the cosine of its argument in radians.

```
X=COS(angle)
```

**COUNT (COU.) Character count (function)**

Returns the number of characters sent to the output stream (VDU or printer) since the last new line. For example,

```
PRINT A$;:REPEAT PRINT ".":UNTIL COUNT = 72
```

will pad the line with dots to 72 characters.

**DATA (D.) Data (statement)**

Introduces lists of data for use by the READ statement (see READ).

**DEF Define function/procedure (statement)**

Precedes declaration of a user-defined function (FN) or procedure (PROC). DEF must be used at the start of a program line.

For example,

```
DEF FNcelsius(f) = (f-32)*5/9
```

defines a function to convert Fahrenheit to Celsius. Executing

```
PRINT FNcelsius(98.4)
```

will convert 98.4 to Celsius.

**DEG Degrees (function)**

Returns the argument converted from radians to degrees. For example

```
PRINT=DEG(PI/2)
```

will print 90.

**DELETE (DEL.) Delete lines (command)**

Deletes a group of lines from the program. Both start and end lines of the group will be deleted. For example

```
DELETE 123,456
```

will delete all lines between 123 and 456 inclusive, which need not exist.

**DIM Dimension array (statement)**

Dimensions an array, or reserves an area of memory for special applications. For example,

```
DIM a$(10,20)
```

dimensions a two-dimensional string array `a$` with elements `a$(0,0)` up to `a$(10,20)`. Arrays may have one or more dimensions, and may be string arrays, floating-point arrays, or integer arrays.

```
DIM X%24
```

reserves 25 bytes and puts the address of byte 0 in the variable `X%`.

**DIV Integer divide (operator)**

Gives the integer quotient of two items. The result is always an integer.

```
X=A DIV B
y=(top+bottom+1) DIV 2
```

**ELSE (EL.) Else clause (statement)**

An optional part of the `IF...THEN`, or `ON...GOSUB/GOTO` statements, it introduces the action to be taken if the testable condition evaluates to `FALSE`, or the `ON` expression is out of range.

**END End program (statement)**

Returns to direct mode.

**ENDPROC End procedure (statement)**

Denotes the end of a procedure defined with `DEF PROC`.

**EOF# End of file (function)**

Returns -1 (`TRUE`) if the end of the specified data file has been reached. For example,

```
REPEAT
char%=BGET#data
...
UNTIL EOF#data
```

will read characters until the end of the file whose channel number is the variable `data`.

**EOR Logical Exclusive-OR (operator)**

Performs a bitwise integer logical exclusive-or between two operands which are internally converted to 4 byte integers before the operation.

**ERL Error line (function)**

Returns the line number of the line where the last error occurred. For example,

```
PRINT "Error number" ERR "at line" ERL
```

**ERR Error code (function)**

Returns the error code number of the last error which occurred.

**EVAL (EV.) Evaluate string (function)**

Returns the result of evaluating the given expression supplied as a string. For example,

```
a=6 : b=7  
PRINT EVAL ("a + b")
```

**EXP Exponent (function)**

Returns 'e' (2.71828183) to the power of the argument.

**EXT# Extent of file (function)**

Returns the total length of the file whose channel number is its argument.

The file must have been opened with OPENIN, OPENUP, or OPENOUT.

**FALSE (FA.) False (function)**

Returns the value zero representing logical false. For example,

```
REPEAT PRINT "*" : UNTIL FALSE
```

will continue forever.

**FN Function (statement)**

Introduces a user-declared function. The first character of the function name can be a letter, underline, or a number. No spaces are allowed between the function name and the opening bracket of the parameter list (if any).

**FOR (F.) Start FOR loop (statement)**

Initialises a FOR ... NEXT loop. The loop is executed at least once for each of the values of the control variable in the specified range.

```
FOR card=1 TO 6
PRINT card;
NEXT card
```

will print

```
1           2           3           4           5           6
```

**GET/GET\$ Wait for key (function)**

Waits for a key to be pressed on the keyboard. GET returns the ASCII value, and GET\$ returns the corresponding single-character string. For example,

```
REPEAT UNTIL GET = 13
```

waits for **ENTER** to be pressed.

**GOSUB (GOS.) Call subroutine (statement)**

Calls a section of a program as a subroutine at a specified line number. Control returns to the next statement when RETURN is encountered in the subroutine. One subroutine may call another subroutine (or itself).

```
10 GOSUB 400
20 END
400 PRINT"Hello":RETURN
```

**GOTO (G.) Go to line (statement)**

Transfers program control to a line with a specified or calculated line number. For example,

```
GOTO 100
GOTO (X*10)
```

The use of the calculated GOTO, as in the second example, is not recommended as it will not be renumbered correctly by the RENUMBER command.

**HIMEM (H.) High memory bound (function)**

A pseudo-variable which contains the address of the first byte of free memory.

**IF Condition (statement)**

Sets up a test condition which can be used to control the subsequent flow of the program. It is part of the IF ... THEN ...ELSE structure. The word THEN is optional under most circumstances.

```
IF length=5 THEN 110
IF A<C OR A>D GOTO 110
IF A>C AND C>-D THEN GOTO 110 ELSE PRINT "CCL"
```

**INKEY/INKEY\$ Read key (function)**

Waits for up to a specified number of clock ticks (10ms each). If no key is pressed in the time limit, INKEY will return -1 and INKEY\$ will return a null string; otherwise the INKEY function will return the ASCII value of the key pressed.

**INPUT (I.) Input value (statement)**

Inputs values from the keyboard.

The INPUT statement normally prints a ? prompt for each variable in the list. Alternatively strings can be included in the list of variables to be printed as prompts; omitting the comma after a string will suppress the question mark. For example:

```
INPUT"Enter your age:" age%, "and your name",name$
```

**INPUT LINE** **Input a line (statement)**

Identical to INPUT except that the entire line, including commas, quotes and leading spaces is input into a string variable.

```
INPUT LINE A$
```

**INPUT#** **Input from file (statement)**

Reads data from a file into specified variables.

The data should have been written to the file with a corresponding PRINT# statement.

**INSTR** **Substring (function)**

Returns the position of a substring within a string, optionally starting the search at a specified place in the string. The leftmost character position is 1. If the sub-string is not found, 0 is returned.

For example,

```
PRINT INSTR("Z88", "8")
```

will print 2, and

```
PRINT INSTR("PipeDream", "e", 5)
```

will start the search at character 5 and print 7.

**INT** **Integer (function)**

Converts a real number to the next lower or equal integer.

```
INT(99.8) is 99
```

```
INT(-12) is -12
```

```
INT(-12.1) is -13.
```

**LEFT\$** **Left of string (function)**

Returns a specified number of characters from the left of a string. If there are insufficient characters in the source string, all the characters are returned.

Thus, if A\$="BANANA"



```
PRINT LEFT$(A$,3)
```

would print "BAN".

**LEN Length of string (function)**

Returns the length of the argument string. For example,

```
X=LEN"fred"
```

will set X to 4.

**LET Assignment (statement)**

Optional before an assignment statement.

**LIST (L.) List program (command)**

Lists the program.

Examples

|            |                                |
|------------|--------------------------------|
| LIST       | lists the entire program       |
| LIST ,99   | lists up to line 99            |
| LIST 11,   | lists from line 11 to the end  |
| LIST 11,99 | lists lines 11 to 99 inclusive |
| LIST 55    | lists line 55 only             |

To obtain a listing of a program to a printer connected to the Z88:

- ① Attach and turn on the printer.
- ② Type LIST, type  $\square$ +P, and press **ENTER**.
- ③ When finished, type  $\square$ -P

**LISTO LIST options (command)**

Controls the appearance of a listed program. The number following the command specifies which of the following formatting options are required.

| Value | Option                          |
|-------|---------------------------------|
| 0     | No inserted spaces              |
| 1     | Space after line number         |
| 2     | FOR ... NEXT loops indented     |
| 4     | REPEAT ... UNTIL loops indented |

The numbers can be added to combine options, the default being 7.

**LN Natural logarithm (function)**

Returns the natural (Naperian) logarithm of its argument.

**LOAD (LO.) Load program (command)**

Loads a new program from a file and clears the variables. For example

```
LOAD "STAT4" or
LOAD ":RAM.0/CONVERTER.BAS"
```

**LOCAL (LOC.) Local variables (statement)**

Declares variables for local use inside a function (FN) or procedure (PROC).

```
LOCAL A$,X,Y%
```

**LOG Logarithm (function)**

Returns the base-10 logarithm of its argument.

**LOMEM (LOM.) Lower memory bound (function)**

A pseudo-variable which controls where in memory the dynamic data structures are to be placed. The default is TOP, the first free address after the end of the program.

**MID\$ Middle of string (function)**

Returns a string consisting of a specified number of characters of the string starting from a given position. For example

```
A$ = MID$(B$, start, length)
```

sets A\$ to the substring of B\$ starting at position 'start', and of length 'length'. If 'length' is omitted, or if there are insufficient characters in the string, then all the characters from 'start' onwards are returned. Thus

```
PRINT MID$("DOZY",2,2)
```

will print

```
"OZ"
```

**MOD Modulo (operator)**

Gives the signed remainder of the integer division.

```
X=A MOD B
```

is equivalent to

```
X = A - ((A DIV B) *B)
```

**NEW New program (command)**

Initialises the interpreter for a new program to be typed in. An old program may be recovered with the OLD command provided no program lines have been typed in. The variables @% and A% to Z% are preserved even after a NEW command.

**NEXT(N.) End FOR loop (statement)**

Ends a FOR ... NEXT loop. NEXT takes an optional control variable; if this is not the same as the variable supplied in the corresponding FOR statement, an error will occur.

**NOT Logical NOT (operator)**

A unary operator (the same priority as unary -) giving a bit-by-bit binary inversion of the constant, variable, or mathematical or boolean expression to its right. Usually used in IF ... THEN or UNTIL statements to invert the sense of the condition. Expressions must be enclosed in brackets.

**OLD Recover old program (command)**

Undoes the effect of NEW provided no lines have been typed in or deleted, no variables have been created, and no popdown or application has been entered.

**ON Multi-way switch (statement)**

Provides a multi-way GOTO or GOSUB, depending on the value of a control variable. The line numbers in the list may be constants or calculated, and the unwanted ones are skipped without calculation. For example:

```
ON action GOSUB 1000,2000,3000,4000
```

**ON ERROR Error trap (statement)**

Provides error trapping. If an ON ERROR statement has been encountered, BASIC will transfer control to it (without taking any reporting action) when an error is detected. This allows error reporting/recovery to be controlled by the program. However, the program control stack is still cleared when the error is detected and it is not possible to return to the point where the error occurred.

Note that under some circumstances ON ERROR can cause BASIC to generate repeated errors, requiring a soft-reset. This can be avoided by including a call to INKEY\$, as in the following example, which will allow you to exit from BASIC to the Index and ◊KILL the activity:

```
10 ON ERROR REPORT: Q$=INKEY$(100)
20 ERROR
```

**OPENIN (OP.) Open file for input (function)**

Opens a file for reading or updating and returns the 'channel number' of the file, or 0 on failure. This number must be used in subsequent references to the file with BGET#, INPUT#, EXT#, PTR#, EOF# or CLOSE#.

**OPENOUT Open file for output (function)**

Opens a file for writing and returns the 'channel number' of the file, or 0 on failure. This number must be used in subsequent references to the file with BPUT#, PRINT#, EXT#, PTR# or CLOSE#.

```
X=OPENOUT(A$)
X=OPENOUT(" :RAM.0/DATA.DAT")
```

**OPENUP (OPENU.) Open file for update (function)**

Opens a file for update and returns the channel number, or 0 on failure. Once a file is opened you can update it or extend it.

**OPT Assembler options (statement)**

An assembler pseudo operation controlling the method of assembly.

It is followed by a number in the range 0 to 3 to specify the method of assembly:

| Option | Action                        |
|--------|-------------------------------|
| 0      | errors suppressed, no listing |
| 1      | errors suppressed, listing    |
| 2      | errors reported, no listing   |
| 3      | errors reported, listing      |

The code is assembled into memory at the address specified by P%. For example:

```
10 DIM code 100
20 FOR pass = 0 TO 3 STEP 3
30 P%=code
40 [
50 OPT pass
60 .....
70 \ backslash introduces a comment
80 \ standard Z80 mnemonics are used
90 ]
100 NEXT pass
110 END
```

Alternatively the assembled code can be assembled into memory at the address specified by O%, with labels generated according to the value of P%, by adding 4 to each of these option values.

**OR Logical OR (operator)**

Gives the bitwise integer logical OR between two operands which are internally converted to 4 byte integers before the operation.

**OSCLI Operating-system command (statement)**

Allows a string expression to be passed to the operating system. For example, in the BASIC editor (see **Editing BASIC programs**, p. 197)

```
60220 OSCLI "*CLI.<" + B$
```

**PAGE (PA.) Program area (function)**

A pseudo-variable controlling the starting address of the current user program area. The lower byte of PAGE is always zero.

**PI Pi (function)**

Returns 3.141592653.

**POS Cursor position (function)**

Returns the horizontal position of the cursor on the screen. The left-hand column is 0 and the right-hand column is one less than the width of the display.

**PRINT (P.) Print text (statement)**

Prints characters on the screen or printer.

Items may be separated by commas, semi-colons, or no separator:

```
PRINT "ONE" I% "TWO"
```

Numbers are printed in a format determined by the value of the variable @%. This is set to a hexadecimal value as follows:

```
@% = &SSNNPPWW
```

where

*SS* determines the format of strings created by *STR\$*.

If *SS=01* then *STR\$* will use the format specified by *@%*, otherwise *@%* will be ignored.

*NN* determines the notation format.

*NN=00* General notation: integers will be printed with no decimal places, numbers between 0.1 and 1 will be printed as 0.1 etc, and numbers less than 0.1 will use scientific notation.

*NN=01* Scientific notation: eg 100 is printed as 1E2.

*NN=02* Fixed format notation: if the number will fit into the specified field width, it will be displayed with the number of decimal places specified by *PP*. Otherwise general notation will be used.

*PP* determines the number of decimal places to be printed.

*WW* determines the overall print field width.

By default, *@%* = *&0000090A*, giving general notation with a field width of 10 characters. Its value can be printed, in hexadecimal, with

```
PRINT ~@%
```

Numbers can be printed in hexadecimal by prefixing them with *'~'*.

**PRINT# (P.#) Write to file (statement)**

Writes the internal form of a list of variables, separated by commas, to a specified data file.

**PROC Procedure (statement)**

Introduces a user-declared procedure. The first character of a procedure name can be a letter, underline, or a number. No spaces are allowed between the procedure name and the opening bracket of the parameter list (if any). The procedure returns to the calling program with an *ENDPROC* statement.

**PTR# File pointer (function)**

A pseudo-variable allowing the random-access pointer of a specified file to be read and changed. For example,

```
PTR#F=PTR#F+5
```

moves to the next floating-point number in the file with channel number F, since 5 bytes are allocated to each number.

**PUT Output to port (statement)**

Outputs data to a Z80 port. Should only be used by experienced programmers as incorrect use could damage the Z88. The full Z80 extended addressing is available.

```
PUT A,N :REM output N to port A.
```

**RAD Radians (function)**

Returns its argument converted from degrees to radians. For example:

```
RAD(90)
```

**READ Read DATA statements (statement)**

Assigns to variables values read from the DATA statements in the program. Strings must be enclosed in double quotes if they have leading spaces or contain commas.

```
READ A%,B,C$
DATA 27,-12.34,"Hello"
```

**REM Comment (statement)**

Introduces a comment, causing the rest of the line to be ignored.

**RENUMBER (REN.) Renumber program (command)**

Renumbers the lines and corrects the cross references inside a program. The options are as for AUTO.

**REPEAT (REP.) REPEAT loop (statement)**

Introduces a REPEAT...UNTIL loop. For example:

```
REPEAT PRINT "*";
UNTIL COUNT = 80
```

will print 80 stars on the screen or printer.



**REPORT (REPO.) Report error (statement)**

Prints out the error string associated with the last error which occurred. If no error has occurred, prints the copyright string.

**RESTORE (RES.) Restore READ (statement)**

Sets the line from which subsequent READ statements will read data.

**RETURN (R.) Return from subroutine (statement)**

Causes a RETURN to the statement after the most recent GOSUB statement.

**RIGHT\$ Right of string (function)**

Returns a specified number of characters from the right-hand end of a string. If there are insufficient characters in the string then all are returned. For example:

```
PRINT RIGHT$("DOZY",3)
```

will print OZY.

**RND Random number (function)**

Returns a random number. The type and range of the number returned depends upon the optional parameter, as follows:

| Value | Result of RND(X)                                    |
|-------|-----------------------------------------------------|
| X<0   | Returns X and resets random number generator to -X. |
| X=0   | Repeats last random number given by RND(1).         |
| X=1   | Returns a random number between 0 and 0.999999.     |
| X>1   | Returns a random integer between 1 and X inclusive. |

**RUN Run program (statement)**

Starts execution of the program after clearing all but the static variables @%, and A% to Z%.

**SAVE (SA.) Save program (statement)**

Saves the current program area to a file, in internal (tokenised) format.

```
SAVE "myprog.BAS"  
SAVE A$
```

**SGN Sign (function)**

Returns -1, 0, or +1 depending on whether the argument is negative, zero or positive respectively.

```
result=SGN(answer)
```

**SIN Sine (function)**

Returns the sine of its argument taken in radians.

**SPC Print spaces (statement)**

Prints a specified number of spaces. SPC can only be used as part of an INPUT or PRINT list; for example:

```
PRINT "Name"; SPC(4); "Age"; SPC(6); "Address"
```

**SQR Square root (function)**

Returns the positive square root of its argument.

```
z=SQR (x^2+y^2)
```

**STEP (S.) FOR loop increment (statement)**

Part of the FOR statement, this optional section specifies the step size. For example,

```
FOR i=1 TO 20 STEP 5  
PRINT i;  
NEXT
```

will print: 1 6 11 16

**STOP Stop program (statement)**

Syntactically identical to END, STOP also prints a message

```
STOP at line X
```

where X is the line number.

**STR\$ String (function)**

Returns the string form of the numeric argument as it would have been printed. A number A% can be converted to a string in hexadecimal format with the function:

```
STR$~A%
```

**STRING\$ Repeat strings (function)**

Returns a given number of repetitions of a string.

```
A$=STRING$(5,"HA")
```

will set A\$ to "HAHAHAHAHA".

**TAB Move to screen position (statement)**

Moves the cursor to a given screen position. TAB can only be used as part of a PRINT or INPUT statement.

There are two forms:

TAB(X) will print spaces until the cursor reaches column X (on the same line, or next line).

TAB(X,Y) will move the cursor directly to character position X,Y on the screen, where 0,0 corresponds to the top left-hand corner.

**TAN (T.) Tangent (function)**

Returns the tangent of its argument taken in radians.

**THEN (TH.) Condition clause (statement)**

An optional part of the IF ... THEN ... ELSE statement. It introduces the action to be taken if the testable condition evaluates to TRUE.

**TIME (TI.) Time (function)**

A pseudo-variable which sets and reads the elapsed time clock. The value of TIME must be initialised before it is used; for example

```
TIME=100
```

resets the value of TIME to 100 centiseconds, and

```
X=TIME
```

sets X to the value of the current elapsed time.

**TIMES\$ Time string (function)**

Returns a string giving the current date and time; for example:

```
Wednesday 29 April 1987, 10:12:32
```

The functions LEFT\$, MID\$, and RIGHT\$ can be used to extract parts of this string. For example, the time alone can be obtained by

```
A$ = RIGHT$(TIME$,8)  
PRINT A$
```

```
10:12:32
```

**TO Upper bound of FOR loop (statement)**

Introduces the terminating value for the loop in a FOR ... TO ... STEP statement. When the loop control variable exceeds the value following 'TO', the loop is terminated.

**TOP Top of program (function)**

Returns the value of the first free location after the end of the current program.

**TRACE (TR.) Trace program (command)**

TRACE can be used to provide information on the execution of a program. TRACE ON causes the interpreter to print executed line numbers when it encounters them, for debugging. The facility can be turned off by typing TRACE OFF.

- 
- TRUE True (function)**  
Returns the value -1, representing logical true.
- UNTIL (U.) End REPEAT loop (statement)**  
The end of a REPEAT ... UNTIL structure.
- USR Call machine-code (function)**  
Enters a machine code routine at the address specified in its argument, passing the least-significant bytes of the integer variables A%, B%, C%, D%, E%, F%, H%, L%, and F% into the correspondingly-named registers of the Z80 on entry.  
  
Unlike CALL, USR returns a 32-bit result composed of the contents of the Z80's H, L, H', and L' registers, most-significant to least-significant.  
  
This function should only be used by experienced programmers.
- VAL Value of string (function)**  
Converts a character string representing a number into numeric form.  
  
`X=VAL(a$)`
- VDU (V.) Output bytes to screen (statement)**  
Takes a list of numeric arguments and sends their least-significant bytes as characters to the current 'output stream'.
- VPOS (VP.) Vertical position (function)**  
Returns the vertical cursor position. The top of the screen is line 0.
- WIDTH (W.) Screen width (statement)**  
Controls output overall field width. Initially WIDTH is 94 (the default). For example, before printing it is a good idea to set  
  
`WIDTH 80`  
  
to give a new line after every 80 characters of output.

**\*CLI Send line to CLI (OZ command)**

Sends a command to the command line interpreter. For example, in the BASIC editor (see **Editing BASIC programs**, p. 197):

```
60090 *CLI .*:RAM.0/EE.CLI
```

**\*ERASE Erase a file (OZ command)**

Erases a specified file. For example,

```
*ERASE filename
```

or using the CLI

```
OSCLI "*ERASE "+file$
```

**\*NAME Names the BASIC activity (OZ command)**

Gives the BASIC activity a name, which will be displayed in the list of **SUSPENDED ACTIVITIES** in the Index.

```
*NAME MYPROG
```

**\*RENAME Rename a file (OZ command)**

Renames a file; for example:

```
*RENAME oldfile newfile
OSCLI "*RENAME "+oldfile$+" "+newfile$
```

**Special Z88 information**

The following system information is available:

|                |                                                                                          |
|----------------|------------------------------------------------------------------------------------------|
| PRINT ~PTR# -1 | The number of channels left for use and the ROM release number                           |
| PRINT EXT# -1  | Prints the estimated free memory in bytes                                                |
| PRINT EOF# -1  | Returns 0 for an unexpanded Z88, and -1 for an expanded Z88 with at least 128K in slot 1 |

---

# BASIC operators

---

The following operators may be used as part of expressions.

## Arithmetic operators

The arithmetic operators take two numbers as operands.

|   |                    |   |          |
|---|--------------------|---|----------|
| + | add                | - | subtract |
| * | multiply           | / | divide   |
| ^ | raise to the power |   |          |

## Relational operators

The relational operators can compare numbers, and return a logical value of FALSE=0 and TRUE=-1.

|    |                       |    |                          |
|----|-----------------------|----|--------------------------|
| <  | less than             | =  | equal to                 |
| <= | less than or equal to | >  | greater than             |
| <> | not equal to          | >= | greater than or equal to |

## Logical operators

The logical operators operate on numeric or logical values. Boolean FALSE is taken as zero, TRUE as -1.

## Indirection operators

The following operators allow the programmer to access memory directly (called PEEK in other versions of BASIC) or to alter the contents of specified memory locations (called POKE in other BASICs).

These operators should only be used by experienced programmers, since they give the programmer the capability of altering the operation of other activities in the Z88 operating system; in general, only addresses within the region allocated by a BASIC DIM statement should be altered.

|    |                    |   |                  |
|----|--------------------|---|------------------|
| ?  | byte indirection   | ! | word indirection |
| \$ | string indirection |   |                  |

The usual way of using these operators is to allocate a vector using the DIM statement, and then manipulate elements of this vector with the indirection operators. For example,

```
DIM vec 15
```

allocates a vector of 16 bytes, and assigns its address to the variable `vec`. These bytes can be addressed as

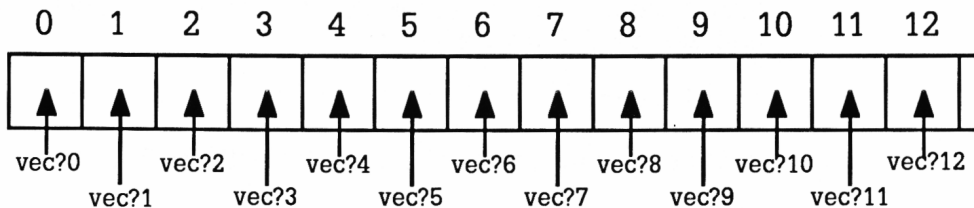

Note that `!vec` is an alternative way of writing `vec!0`.

A typical manipulation might be

```
vec!1 = vec!1 + 1
```

Alternatively the vector could be addressed as 4 four-byte words:

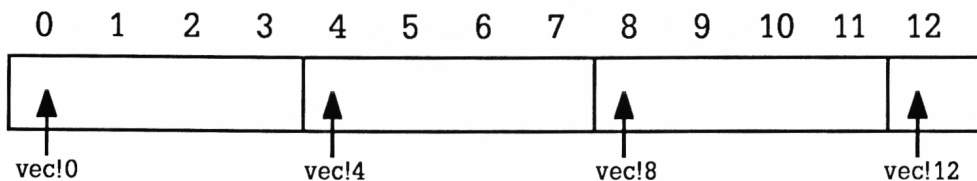

Finally, the string indirection operator allows a string to be stored directly into an area of memory. For example:

```
$vec = "Z88 COMPUTER"
```

stores characters in the vector as follows:



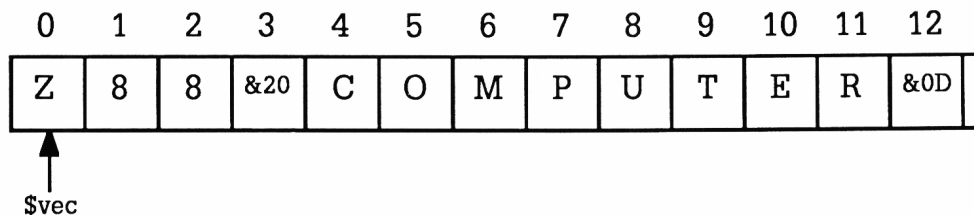

The string can be accessed with the \$ operator, so the following statement will print the string:

```
PRINT $vec
```

Individual characters can be accessed with the ? operator.

## Order of precedence

The order of precedence of the operators is as follows:

|         |     |                          |
|---------|-----|--------------------------|
| Group 1 | -   | unary minus              |
|         | ()  | brackets                 |
|         | NOT | logical NOT              |
| Group 2 | ^   | raise to the power       |
| Group 3 | *   | multiply                 |
|         | /   | divide                   |
| Group 4 | +   | add                      |
|         | -   | subtract                 |
| Group 5 | <   | less than                |
|         | =   | equal to                 |
|         | <=  | less than or equal to    |
|         | >   | greater than             |
|         | <>  | not equal to             |
|         | >=  | greater than or equal to |
| Group 6 | AND | Logical AND              |
| Group 7 | OR  | Logical OR               |
|         | EOR | Logical Exclusive-OR     |

so, for example,  $A-B*C^D$  is equivalent to  $A-(B*(C^D))$ .



---

# APPENDICES

|                                           |            |
|-------------------------------------------|------------|
| <b>Appendix A – Replacing batteries</b>   | <b>229</b> |
| <b>Appendix B – Serial port</b>           | <b>231</b> |
| <b>Appendix C – Error messages</b>        | <b>233</b> |
| PipeDream error messages                  | 233        |
| Diary error messages                      | 235        |
| BASIC error messages                      | 236        |
| <b>Appendix D – Z88 character set</b>     | <b>237</b> |
| <b>Appendix E – PipeDream file format</b> | <b>240</b> |
| <b>Appendix F – Z88 specification</b>     | <b>243</b> |
| <b>Index</b>                              | <b>245</b> |



---

## Appendix A

# Replacing batteries

---

If the battery low symbol appears as soon as the Z88 is switched on, the safest course of action is to replace the batteries as soon as possible. The computer should be switched off until new batteries have been obtained.

The replacement batteries should be Alkaline cells, size AA, type MN1500 or LR6.

Note that while you are exchanging batteries, the contents of the machine's memory will be kept intact by the internal super capacitor. However, this will only maintain power for a limited time, so it is recommended that you power the Z88 from the mains power unit while changing batteries, especially if extra cards are fitted.

In the absence of a mains unit, carry out the following actions promptly, and bear in mind the time limitations given below.

### **Memory retention time**

The time available depends on the number of RAM cards fitted. With no RAM cards the machine will retain its data for 3 minutes. With one RAM card this will be reduced to about 1 minute. Use of two RAM cards will lead to a further reduction to about 30 seconds.

It is not recommended that the machine be fitted with three RAM cards as this would require the use of slot 3 which is designed primarily for use with EPROM cards and, although it is possible to use it with RAM, a much higher power consumption would result.

The time limit does not depend on the size of RAM card used. EPROM cards do not affect the time limit in any slot.

The times given are for the worst case situation. In general the limit will be twice as high, but this should not be relied upon.

If you have a mains adaptor you can use it to power the Z88 while you change batteries.

### Procedure

Read the following procedure carefully, so that you can carry it out without pausing:

- ① Remove the new batteries from their packaging, and place them within easy reach on the right-hand side of the Z88.
  - ② Switch the Z88 off by pressing both **SHIFT** keys simultaneously.
  - ③ Place the Z88 keyboard-down, and remove the lid of the battery compartment.
  - ④ Note the time, and calculate how long you have according to the table given on the previous page.
  - ⑤ Remove the four batteries from the battery compartment, if necessary tilting the Z88 to slide the batteries out.
  - ⑥ Throw the old batteries away, to avoid confusing them with the new replacements.
  - ⑦ Place one of the new batteries at each end of the battery compartment, observing the polarity carefully. Place the remaining two batteries in an 'A' shape, and press down on the point of the 'A' so that they pop into place.
  - ⑧ Check that the batteries are all orientated correctly. There is now no longer any time pressure.
  - ⑨ Replace the battery-compartment lid firmly before turning the machine over again.
- DO NOT PRESS RESET.
- ⑩ Switch on, by pressing both **SHIFT** keys simultaneously. The Z88 should now be working, and the battery-low indicator will not be displayed.

---

# Appendix B      Serial port

---

This appendix describes the pin connections for the Z88 serial connector.

The following connections are for a cable to connect the Z88 serial port connector to a 25-pin D-type serial printer connector, or equivalent:

| Z88<br>9 way D (Male) |     | Printer -<br>25 way D (Male) |
|-----------------------|-----|------------------------------|
| 1                     | -   | -                            |
| 2                     | TxD | → 3 RxD                      |
| 3                     | RxD | ← 2 TxD                      |
| 4                     | RTS | → 5 CTS                      |
| 5                     | CTS | ← 20 DTR                     |
| 6                     | -   | -                            |
| 7                     | GND | 7 GND                        |
| 8                     | DCD | ← 20 DTR                     |
| 9                     | DTR | → 6, 8 (DSR, DCD)            |

where the signals are as follows:

|     |                     |
|-----|---------------------|
| TxD | Transmitted data    |
| RxD | Received data       |
| RTS | Request to send     |
| CTS | Clear to send       |
| GND | Signal ground       |
| DCD | Data carrier detect |
| DTR | Data terminal ready |

## Notes

The Z88 RS232 port is wired as Data Terminal Equipment

Pin 1 must not be used for RS232 signals. It carries +5v at 10 $\mu$ A, even when the machine is OFF.

Do not use pin 6 on the Z88 connector.

Pin 9 is the RS232 DTR signal. It provides +5v at 1mA while the Z88 is switched on, for powering CMOS serial to parallel converters.

CTS on the Z88 must be high for the Z88 to transmit, and DCD must be high for the Z88 to receive. For simple RS232 use, connect pins 5 and 8 to pin 9, and connect pins 2 (TxD), 3 (RxD), and 7 (GND) to the other computer.

A **Suspended** message will be displayed if a battery low is flagged while sending or receiving, or if the Z88 is switched off or the flap is opened. In this case you must repeat the transfer.



---

# Appendix C      Error messages

---

## PipeDream error messages

|                        |                                                                                                                                                                                         |
|------------------------|-----------------------------------------------------------------------------------------------------------------------------------------------------------------------------------------|
| -ve root               | The argument to the SQR function was negative; eg SQR(-1).                                                                                                                              |
| All columns zero width | Attempt to set the width of all columns to zero.                                                                                                                                        |
| Bad argument           | The argument to a <b>Next Match</b> (◊BNM) command was given with no prior <b>Search</b> command.                                                                                       |
| Bad column             | The <b>Sort</b> (◊BSO) command was given with an invalid column specification.                                                                                                          |
| Bad date               | The argument to the DAY, MONTH, or YEAR function is not a valid date; eg DAY(27).                                                                                                       |
| Bad file               | The file specified was not a valid file.                                                                                                                                                |
| Bad index              | A CHOOSE, or INDEX function was called with an invalid index; eg CHOOSE(-2,1).                                                                                                          |
| Bad list file          | The list file loaded by the <b>Load</b> command (◊FL) does not contain valid file names, or was not saved with the <b>Save Plain text</b> option.                                       |
| Bad name               | The name specified in a <b>Load</b> , <b>Save</b> , or <b>Name</b> command was not a valid file name.                                                                                   |
| Bad number             | The argument to an <b>Insert Highlights</b> (◊PHI), <b>Remove Highlights</b> (◊PHR), <b>Highlight Block</b> (◊PHB), or <b>Decimal Places</b> (◊LDP) command was not in the valid range. |
| Bad option             | The option was not valid for the command.                                                                                                                                               |
| Bad range              | The range of slots specified in a <b>Replicate</b> or <b>Save</b> command was not a valid range; eg,<br><br>Save only range of columns C A.                                             |
| Bad slot               | The command was given an invalid slot reference; eg <b>Go to Slot</b> (◊CGS) A0.                                                                                                        |

---

|                     |                                                                                                                                                 |
|---------------------|-------------------------------------------------------------------------------------------------------------------------------------------------|
| Bad ^ field         | The ^ sequence in a <b>Search</b> or <b>Replace</b> string was invalid; eg<br><b>String to search for ^H</b>                                    |
| Divide by 0         | An expression attempted to divide by zero; eg 2/0.                                                                                              |
| Edge                | The block being copied or moved would not fit within the maximum possible sheet size; eg, an attempt to copy from A1 Z6 to AA1.                 |
| Editing expression  | The specified command is not available while editing an expression; eg, <b>Load</b> (◊FL).                                                      |
| End of list file    | The end of the List file has been reached; eg <b>Bottom File</b> (◊FB) at the end of a document.                                                |
| Escape              | The <b>[ESC]</b> key was pressed while processing a document.                                                                                   |
| Exp range           | The range of the EXP function was exceeded; eg EXP(100).                                                                                        |
| Expression too long | The string of text is too long to be entered into a slot; ie longer than 240 characters.                                                        |
| FP overflow         | An expression resulted in a number too large to be represented; eg, 100^100.                                                                    |
| Log range           | The argument to the LOG function was invalid; eg LOG(-1).                                                                                       |
| Lookup              | The LOOKUP function could not find a successful match.                                                                                          |
| Loop                | Two slots containing string values reference each other.                                                                                        |
| Memory full         | No more memory is available for the current sheet.                                                                                              |
| No list file        | A multi-file command such as <b>Bottom File</b> (◊FB) was given with no List file loaded, or after the List file was cancelled due to an error. |
| No marked block     | The command requires a marked block; eg <b>Move</b> .                                                                                           |
| Overlap             | The source and destination blocks, specified in a <b>Move</b> or <b>Copy</b> command, overlap.                                                  |
| Propagated          | The expression slot refers to another slot with an error.                                                                                       |
| Stack overflow      | The expression is too complex for evaluation.                                                                                                   |

---

|                   |                                                                                                                                                                                                                             |
|-------------------|-----------------------------------------------------------------------------------------------------------------------------------------------------------------------------------------------------------------------------|
| Too few arguments | An IF, CHOOSE, or INDEX function has been specified with too few arguments; eg, INDEX(2).                                                                                                                                   |
| Too long          | The length of line that would result after a <b>Join Lines</b> or <b>Replace</b> command is longer than 240 characters, or the string specified in a <b>Search</b> or <b>Replace</b> command is longer than 240 characters. |
| Too many columns  | The <b>Add Column</b> (◊EAC) or <b>Insert Column</b> (◊EIC) command was given in a document which already has 42 columns, the maximum number.                                                                               |
| Typing error      | The expression is invalid; eg, A1+*3.                                                                                                                                                                                       |

---

### Diary error messages

Diary error messages are displayed in the DIARY DATE window between the date and mode.

|            |                                                                                                                                                                                              |
|------------|----------------------------------------------------------------------------------------------------------------------------------------------------------------------------------------------|
| Memory Low | The user should take immediate action to delete data from the Diary, files, or suspended applications. Delete a line to free memory with ◊ <b>DEL</b> , followed by ◊Y to free more entries. |
| No String  | Tried to <b>Search</b> or <b>Replace</b> with null string.                                                                                                                                   |
| No Room    | The <b>Save Position</b> command (◊CSP) was given with five positions already saved.                                                                                                         |
| No Marker  | <b>Search/Replace</b> between markers etc.                                                                                                                                                   |
| Not Marked | <b>Next/Previous Match</b> ( <b>Search</b> within block) when cursor is outside block.                                                                                                       |
| Date Range | An attempt was made to move outside the legal date range.                                                                                                                                    |
| Overlaps   | A block operation was attempted with the cursor inside the block.                                                                                                                            |
| n Found    | Final message after <b>Replace</b> command.                                                                                                                                                  |

In addition system error messages, such as 'File not found' are displayed in another window on top of the operation being performed.

**BASIC error messages**

|    |                  |     |                  |
|----|------------------|-----|------------------|
| 0  | No room          | 24  | EXP range        |
| 1  | Out of range     | 26  | No such variable |
| 2  | Byte             | 27  | Missing )        |
| 3  | Index            | 28  | Bad hex          |
| 4  | Mistake          | 29  | No such FN/PROC  |
| 5  | Missing          | 30  | Bad call         |
| 6  | Type mismatch    | 31  | Arguments        |
| 7  | No FN            | 32  | No FOR           |
| 8  | \$ range         | 33  | Can't match FOR  |
| 9  | Missing "        | 34  | FOR variable     |
| 10 | Bad DIM          | 36  | No TO            |
| 11 | DIM space        | 38  | No GOSUB         |
| 12 | Not LOCAL        | 39  | ON syntax        |
| 13 | No PROC          | 40  | ON range         |
| 14 | Array            | 41  | No such line     |
| 15 | Subscript        | 42  | Out of DATA      |
| 16 | Syntax error     | 43  | No REPEAT        |
| 17 | Escape           | 220 | Syntax           |
| 18 | Division by zero | 222 | Channel          |
| 19 | String too long  | 252 | End of file      |
| 20 | Too big          | 252 | Suspended        |
| 21 | -ve root         | 252 | File not found   |
| 22 | LOG range        | 252 | Read protected   |
| 23 | Accuracy lost    | 252 | Write protected  |

---

# Appendix D      Z88 character set

---

| Hex | Dec | Code | Description                 | Hex | Dec | Code | Description |
|-----|-----|------|-----------------------------|-----|-----|------|-------------|
| 00  | 0   | NUL  | ◇= Null                     | 20  | 32  |      | Space       |
| 01  | 1   | SOH  | ◇A Start of Heading         | 21  | 33  | !    |             |
| 02  | 2   | STX  | ◇B Start of Text            | 22  | 34  | "    |             |
| 03  | 3   | ETX  | ◇C End of Text              | 23  | 35  | #    |             |
| 04  | 4   | EOT  | ◇D End of Transmit          | 24  | 36  | \$   |             |
| 05  | 5   | ENQ  | ◇E Enquiry                  | 25  | 37  | %    |             |
| 06  | 6   | ACK  | ◇F Acknowledge              | 26  | 38  | &    |             |
| 07  | 7   | BEL  | ◇G Bell                     | 27  | 39  | '    |             |
| 08  | 8   | BS   | ◇H Backspace                | 28  | 40  | (    |             |
| 09  | 9   | HT   | ◇I Horizontal Tab           | 29  | 41  | )    |             |
| 0A  | 10  | LF   | ◇J Line Feed                | 2A  | 42  | *    |             |
| 0B  | 11  | VT   | ◇K Vertical Tab             | 2B  | 43  | +    |             |
| 0C  | 12  | FF   | ◇L Form Feed                | 2C  | 44  | ,    |             |
| 0D  | 13  | CR   | ◇M Carriage Return          | 2D  | 45  | -    |             |
| 0E  | 14  | SO   | ◇N Shift Out                | 2E  | 46  | .    |             |
| 0F  | 15  | SI   | ◇O Shift In                 | 2F  | 47  | /    |             |
| 10  | 16  | DLE  | ◇P Data Line Escape         | 30  | 48  | 0    |             |
| 11  | 17  | DC1  | ◇Q X On                     | 31  | 49  | 1    |             |
| 12  | 18  | DC2  | ◇R Aux On                   | 32  | 50  | 2    |             |
| 13  | 19  | DC3  | ◇S X Off                    | 33  | 51  | 3    |             |
| 14  | 20  | DC4  | ◇T Aux Off                  | 34  | 52  | 4    |             |
| 15  | 21  | NAK  | ◇U Negative Acknowledge     | 35  | 53  | 5    |             |
| 16  | 22  | SYN  | ◇V Synchronous File         | 36  | 54  | 6    |             |
| 17  | 23  | ETB  | ◇W End of Transmitted Block | 37  | 55  | 7    |             |
| 18  | 24  | CAN  | ◇X Cancel                   | 38  | 56  | 8    |             |
| 19  | 25  | EM   | ◇Y End of Medium            | 39  | 57  | 9    |             |
| 1A  | 26  | SUB  | ◇Z Substitute               | 3A  | 58  | :    |             |
| 1B  | 27  | ESC  | ◇[ Escape                   | 3B  | 59  | ;    |             |
| 1C  | 28  | FS   | ◇\ File Separator           | 3C  | 60  | <    |             |
| 1D  | 29  | GS   | ◇] Group Separator          | 3D  | 61  | =    |             |
| 1E  | 30  | RS   | ◇£ Record Separator         | 3E  | 62  | >    |             |
| 1F  | 31  | US   | ◇- Unit Separator           | 3F  | 63  | ?    |             |

| Hex | Dec | Code | Description | Hex | Dec | Code | Description |
|-----|-----|------|-------------|-----|-----|------|-------------|
| 40  | 64  | @    |             | 60  | 96  | ◇'   |             |
| 41  | 65  | A    |             | 61  | 97  | a    |             |
| 42  | 66  | B    |             | 62  | 98  | b    |             |
| 43  | 67  | C    |             | 63  | 99  | c    |             |
| 44  | 68  | D    |             | 64  | 100 | d    |             |
| 45  | 69  | E    |             | 65  | 101 | e    |             |
| 46  | 70  | F    |             | 66  | 102 | f    |             |
| 47  | 71  | G    |             | 67  | 103 | g    |             |
| 48  | 72  | H    |             | 68  | 104 | h    |             |
| 49  | 73  | I    |             | 69  | 105 | i    |             |
| 4A  | 74  | J    |             | 6A  | 106 | j    |             |
| 4B  | 75  | K    |             | 6B  | 107 | k    |             |
| 4C  | 76  | L    |             | 6C  | 108 | l    |             |
| 4D  | 77  | M    |             | 6D  | 109 | m    |             |
| 4E  | 78  | N    |             | 6E  | 110 | n    |             |
| 4F  | 79  | O    |             | 6F  | 111 | o    |             |
| 50  | 80  | P    |             | 70  | 112 | p    |             |
| 51  | 81  | Q    |             | 71  | 113 | q    |             |
| 52  | 82  | R    |             | 72  | 114 | r    |             |
| 53  | 83  | S    |             | 73  | 115 | s    |             |
| 54  | 84  | T    |             | 74  | 116 | t    |             |
| 55  | 85  | U    |             | 75  | 117 | u    |             |
| 56  | 86  | V    |             | 76  | 118 | v    |             |
| 57  | 87  | W    |             | 77  | 119 | w    |             |
| 58  | 88  | X    |             | 78  | 120 | x    |             |
| 59  | 89  | Y    |             | 79  | 121 | y    |             |
| 5A  | 90  | Z    |             | 7A  | 122 | z    |             |
| 5B  | 91  | [    |             | 7B  | 123 | {    |             |
| 5C  | 92  | \    |             | 7C  | 124 | !    |             |
| 5D  | 93  | ]    |             | 7D  | 125 | }    |             |
| 5E  | 94  | ^    |             | 7E  | 126 | ~    |             |
| 5F  | 95  | _    |             | 7F  | 127 | DEL  | Delete      |
|     |     |      |             | A0  | 160 | ...  | Exact space |
|     |     |      |             | A7  | 163 | £    | Pound       |

**Special characters**

These are obtained by executing VDU 1, n from BASIC, where n is the number of the character.

| <b>Code</b> | <b>Character</b>      |
|-------------|-----------------------|
| 32          | Dot space             |
| 33          | Alarm bell            |
| 39          | Aposed '              |
| 42          | Square                |
| 43          | Diamond               |
| 45          | Shift                 |
| 224         | 'SPACE' sign (3 char) |
| 225         | 'ENTER' sign (3 char) |
| 226         | 'TAB' sign (3 char)   |
| 227         | 'DEL' sign (3 char)   |
| 228         | 'ESC' sign (3 char)   |
| 229         | 'MENU' sign (3 char)  |
| 230         | 'INDEX' sign (3 char) |
| 231         | 'HELP' sign (3 char)  |
| 240         | Hollow left arrow     |
| 241         | Hollow right arrow    |
| 242         | Hollow down arrow     |
| 243         | Hollow up arrow       |
| 244         | Head arrow left       |
| 245         | Head arrow right      |
| 246         | Head arrow down       |
| 247         | Head arrow up         |
| 248         | Arrow left            |
| 249         | Arrow right           |
| 250         | Arrow down            |
| 251         | Arrow up              |

**Character modes**

|              |                  |
|--------------|------------------|
| VDU 1,ASC"B" | Bold toggle      |
| VDU 1,ASC"F" | Flash toggle     |
| VDU 1,ASC"G" | Grey toggle      |
| VDU 1,ASC"R" | Reverse toggle   |
| VDU 1,ASC"T" | Tiny font toggle |
| VDU 1,ASC"U" | Underline toggle |

---



---

# Appendix E

# PipeDream file format

---

The PipeDream file format is designed to facilitate manipulation by other programs. Apart from carriage return characters which are used as separators, no control characters or characters above 127 in value appear in the file (unless they have been explicitly typed in). The files are sequential, and can be edited by any text editor.

## PipeDream constructs

Information about the structure of the file is stored in constructs consisting of one or more alphabetic characters between percent signs. Additional information relevant to the construct may be included before the final percent sign.

The file begins with a group of **Options Page constructs** giving the values of the Options Page parameters for the file. This is followed by the main body of the file.

Each column in the file is preceded by a **Column construct** giving details about the column, and followed by an entry for each slot in the column.

Each slot entry may include a collection of constructs giving details about the slot, and is terminated by a carriage return character.

## Options Page construct

%OP%parameter value cr

|           |                                          |
|-----------|------------------------------------------|
| parameter | two characters identifying the parameter |
| value     | the value of the parameter               |
| cr        | carriage return character                |

The various parameter values are:

|    |                |
|----|----------------|
| AM | Auto/manual    |
| BM | Bottom margin  |
| BO | Borders        |
| DE | Title          |
| DP | Decimal places |

|    |                     |
|----|---------------------|
| FM | Footer margin       |
| FO | Footer              |
| HE | Header              |
| HM | Header margin       |
| IW | Insert on wrap      |
| JU | Justify             |
| LM | Left margin         |
| LP | Leading characters  |
| LS | Line spacing        |
| MB | Minus/brackets      |
| PA | Pages               |
| PL | Page length         |
| PS | Page no. start      |
| RC | Rows/columns        |
| TM | Top margin          |
| TN | Text/numbers        |
| TP | Trailing characters |
| WR | Wrap                |

### Column construct

`%C0:column,width,wrap-width%`

|            |                                        |
|------------|----------------------------------------|
| column     | letter identifying the column          |
| width      | decimal number giving the column width |
| wrap-width | decimal number giving the wrap-width   |

These constructs can appear anywhere in the entry for each slot:

|                    |                                                       |
|--------------------|-------------------------------------------------------|
| <code>%B%</code>   | brackets format                                       |
| <code>%C%</code>   | centre align                                          |
| <code>%Dn%</code>  | decimal places, n gives the number                    |
| <code>%DF%</code>  | floating format                                       |
| <code>%F%</code>   | free align                                            |
| <code>%Hn%</code>  | highlight character: n gives the number               |
| <code>%JL%</code>  | justify left                                          |
| <code>%JR%</code>  | justify right                                         |
| <code>%L%</code>   | left align                                            |
| <code>%LC%</code>  | leading character format                              |
| <code>%LCR%</code> | LCR align                                             |
| <code>%Pn%</code>  | page break: n gives the argument, 0 for unconditional |

|      |                           |
|------|---------------------------|
| %PC% | percent character         |
| %R%  | right align               |
| %TC% | trailing character format |
| %V%  | slot is a number slot     |

**General format:**

construct text construct text ... cr

|           |                                          |
|-----------|------------------------------------------|
| construct | one of the constructs above              |
| text      | ASCII characters being the slot contents |
| cr        | carriage return character                |



---

# Appendix F

# Z88 specification

---

|                       |                                                                                                                                                                                 |
|-----------------------|---------------------------------------------------------------------------------------------------------------------------------------------------------------------------------|
| Power source          | 4 x AA Alkaline Cells (MN1500, LR6) providing 20 hours of use<br>AC Mains adaptor (6.5 v DC $\pm$ 10%), 500 mA, centre positive.                                                |
| Weight                | 900 g (1.98 lb).                                                                                                                                                                |
| Dimensions            | 294 mm (L) x 210 mm (D) x 23 mm (H) (11 $\frac{1}{2}$ " x 8 $\frac{1}{4}$ " x $\frac{7}{8}$ ")                                                                                  |
| Keyboard              | QWERTY, silent, 64 keys including INDEX, MENU, and HELP.                                                                                                                        |
| Sound                 | Miniature loudspeaker, used for alarm or warning.                                                                                                                               |
| Serial I/O Port       | RS232, connector 9-way 'D' female.                                                                                                                                              |
| Operating system      | Unique to Z88 (concurrent, 4M Bytes address range).                                                                                                                             |
| Operating temperature | 0°C to 40°C (32°F to 104°F).                                                                                                                                                    |
| Microprocessor        | CMOS Z80                                                                                                                                                                        |
| Internal memory       | RAM CMOS 32K Bytes<br>ROM CMOS 128K Bytes                                                                                                                                       |
| Memory cards          | Slots 1, 2, or 3 1M Byte per card maximum<br>Slot 3 also programs EPROM cards.                                                                                                  |
| CMOS RAM              | Random Access Memory. Data retained while machine is powered.                                                                                                                   |
| CMOS EPROM            | Erasable, Programmable, Read-Only Memory<br>Data retention measured in years. Card can be removed from Z88 without data loss. Eraser available from Cambridge Computer Limited. |



---

# Index

---

## A

ABS (BASIC keyword) 199  
ABS (PipeDream function) 153  
ACS (BASIC keyword) 199  
ACS (PipeDream function) 153  
active days in the Diary 76  
Add Column (PipeDream command)  
123  
Alarm 13, 78  
Align commands in PipeDream 42  
alignment commands in PipeDream  
134  
Alternative font (PipeDream  
command) 148  
AND (BASIC keyword) 199  
application cards 98  
applications 11  
entering 19, 93  
ASC (BASIC keyword) 199  
ASN (BASIC keyword) 200  
ASN (PipeDream function) 154  
assembler 213  
ATN (BASIC keyword) 200  
ATN (PipeDream function) 154  
AUTO (BASIC keyword) 200

## B

BASIC 195  
error messages 236  
programs, editing 182, 197  
running 196  
basic concepts 15  
batteries 6  
inserting 7  
replacing 229  
BBC BASIC 12, 195

Beginning of Line (PipeDream  
command) 115  
BGET# (BASIC keyword) 200  
BLOCKS menu in PipeDream 104  
Bold (PipeDream command) 148  
Bottom File (PipeDream command)  
129  
Bottom of Column (PipeDream  
command) 57, 116  
BPUT# (BASIC keyword) 200

## C

Calculator 13  
functions 70  
Calendar 13  
used with Diary 68  
CALL (BASIC keyword) 201  
CAPS LOCK key 17  
Caps mode 17  
◇CARD 94  
CARD command 94  
CARD error 95, 98  
cards  
errors 95  
installing 94  
Catalogue EPROM (Filer command)  
84  
Catalogue Files (Filer command) 84  
Centre Align (PipeDream command)  
42, 134  
CHAIN (BASIC keyword) 201  
characters, special 239  
CHOOSE (PipeDream function) 154  
CHR\$ (BASIC keyword) 202  
CLEAR (BASIC keyword) 202  
Clear Mark (Diary command) 162  
\*CLI 222  
CLI 179  
CLI file-control commands 180  
CLI files, examples 182  
CLI key sequences 180  
Clock 13, 77  
CLOSE# (BASIC keyword) 202  
CLS (BASIC keyword) 202  
COL (PipeDream function) 154  
column widths in PipeDream 131  
columns in PipeDream 40  
command-line interpreter 179  
computer typeface 4  
constants, in the Calculator 72  
control keys, in Terminal 185  
conventions 4  
Copy (Diary command) 162  
Copy (Filer command) 85  
Copy (PipeDream command) 108  
copying blocks in PipeDream 108  
COS (BASIC keyword) 202  
COS (PipeDream function) 154  
COUNT (BASIC keyword) 202  
COUNT (PipeDream function) 154  
Create Directory (Filer command) 178  
Cursor Down (Diary command) 167  
Cursor Down (PipeDream command)  
116  
Cursor Left (Diary command) 167  
Cursor Left (PipeDream command)  
115  
Cursor Right (Diary command) 167  
Cursor Right (PipeDream command)  
115  
Cursor Up (Diary command) 167  
Cursor Up (PipeDream command) 116  
cursor keys 16  
in PipeDream 38  
cursor operations  
in PipeDream 117  
in the Diary 169

- D**
- DATA (BASIC keyword) 203
  - data transfer 231
  - database example 46
  - date format 88
  - dates in PipeDream 152
  - DAY (PipeDream function) 155
  - Decimal Places (PipeDream command) 63
  - Decimal Places (PipeDream command) 136
  - DEF (BASIC keyword) 203
  - Default Format (PipeDream command) 137
  - DEG (BASIC keyword) 203
  - DEG (PipeDream function) 155
  - DEL key 16
    - in PipeDream 38
  - DELETE (BASIC keyword) 203
  - Delete (Diary command) 163
  - Delete (PipeDream command) 108
  - Delete Character (PipeDream command) 40, 119
  - Delete Column (PipeDream command) 121
  - Delete Line (Diary command) 171
  - Delete Row (PipeDream command) 121
  - Delete Row in Column (PipeDream command) 120
  - Delete to End of Line (Diary command) 170
  - Delete to End of Slot (PipeDream command) 120
  - Delete Word (Diary command) 170
  - Delete Word (PipeDream command) 119
  - device specification 176
  - devices 81
  - Diary 12, 65
    - error messages 235
    - screen 65
    - use with Calendar 68
  - DIM (BASIC keyword) 203
  - DIV (BASIC keyword) 204
  - Down Directory (Filer command) 178
- E**
- EDIT menu in PipeDream 118
  - Edit Expression (PipeDream command) 58
  - Edit Expression (PipeDream command) 123, 150
  - editing expression slots in PipeDream 123
  - editing within a slot in PipeDream 119
  - ELSE (BASIC keyword) 204
  - END (BASIC keyword) 204
  - End of Line (Diary command) 167
  - End of Line (PipeDream command) 115
  - ENDPROC (BASIC keyword) 204
  - ENTER (Diary command) 166
  - ENTER (PipeDream command) 116
  - ENTER key 16
    - in PipeDream 39
  - EOF# (BASIC keyword) 204
  - EOR (BASIC keyword) 205
  - EPROM cards 96
  - EPROM eraser 97
  - EPROMs, use with Filer 85
  - \*ERASE 222
  - Erase (Filer command) 86
  - ERL (BASIC keyword) 205
  - ERR (BASIC keyword) 205
  - error messages
    - BASIC 236
    - Diary 235
    - PipeDream 233
  - ESC key 16
  - Escape (PipeDream command) 124
  - EVAL (BASIC keyword) 205
  - exact space 17, 121
  - Execute (Filer command) 178, 179
  - executing a file on reset 183
  - executing a program from the Alarm 79
- Exit (Terminal command) 185**
- EXP (BASIC keyword) 205**
- EXP (PipeDream function) 155**
- expression slots 36, 58, 150**
- EXT# (BASIC keyword) 205**
- Extended Sequence (PipeDream command) 148**
- extensions, in file names 81**
- F**
- FAIL error 95**
- FALSE (BASIC keyword) 205**
- FCC compliance iii**
- Fetch from EPROM (Filer command) 85**
- File name, in PipeDream 125**
- file names 81**
- full specification 175
- Filer 13, 80**
- Filer commands 83, 177**
- Filer reference 175**
- FILES menu in PipeDream 125**
- FILES menu in PrinterEd 193**
- finding information in PipeDream 52**
- First Active Day (Diary command) 169**
- First Column (PipeDream command) 57, 116**
- First Line (Diary command) 167**
- Fix Column (PipeDream command) 135**
- Fix Row (PipeDream command) 135**
- FN (BASIC keyword) 206**
- foot 7**
- footers in PipeDream 142**
- FOR (BASIC keyword) 206**
- Format Paragraph (PipeDream command) 120**
- format, PipeDream 240**
- formatting in PipeDream 35, 121**
- Free Align (PipeDream command) 135**
- functions in PipeDream 153**
- FX800 printer 187**



**G**

GET/GET\$ (BASIC keyword) 206  
Go to Slot (PipeDream command) 114  
GOSUB (BASIC keyword) 206  
GOTO (BASIC keyword) 207

**H**

hard reset 24  
headers in PipeDream 142  
headings, fixing 135  
HELP key 16  
help 25  
hierarchical filing system 80  
Highlight Block (PipeDream command) 149  
highlight codes 42, 148  
    in PrinterEd 188  
highlight commands 41  
highlighting text 148  
HIMEM (BASIC keyword) 207  
home expenses example 56

**I**

IF (BASIC keyword) 207  
IF (PipeDream function) 155  
Import/Export 14, 90  
    protocol 91  
INDEX (PipeDream function) 155  
INDEX error 95  
INDEX key 16  
Index 13, 18  
    screen 18, 92  
INKEY/INKEY\$ (BASIC keyword) 207  
INPUT (BASIC keyword) 207  
INPUT# (BASIC keyword) 208  
INPUT LINE (BASIC keyword) 208  
Insert Character (Diary command) 171  
Insert Character (PipeDream command) 119  
Insert Column (PipeDream command) 122

Insert Highlights (PipeDream command) 149  
Insert Line (Diary command) 171  
Insert Page (PipeDream command) 121  
Insert Reference (PipeDream command) 123  
Insert Row (PipeDream command) 41, 122  
Insert Row in Column (PipeDream command) 120  
insert mode in PipeDream 119  
Insert/Overtyp (Diary command) 170  
Insert/Overtyp (PipeDream command) 119  
inserting a line in PipeDream 41  
INSTR (BASIC keyword) 208  
INT (BASIC keyword) 208  
INT (PipeDream function) 156  
Inverted Caps mode 17  
    in BASIC 197  
Italic (PipeDream command) 148

**J**

jam sequence, in CLI 181  
Join Lines (Diary command) 171  
Join Lines (PipeDream command) 120

**K**

keyboard 15  
keyboard options 87  
keyboard, cleaning 17  
keycap legends 5  
◊KILL 20, 94  
KILL 98

**L**

Last Active Day (Diary command) 168  
Last Column (PipeDream command) 57, 116  
Last Line (Diary command) 167  
LAYOUT menu in PipeDream 131

layout, altering in PipeDream 42  
LCR Align (PipeDream command) 134  
Leading Characters (PipeDream command) 63, 136  
Left Align (PipeDream command) 134  
LEFT\$ (BASIC keyword) 208  
LEN (BASIC keyword) 209  
LET (BASIC keyword) 209  
line editing 24  
LIST (BASIC keyword) 209  
List (Diary command) 163  
list file 126, 128  
LISTO (BASIC keyword) 209  
lists in expression slots 152  
LN (BASIC keyword) 210  
LN (PipeDream function) 156  
LOAD (BASIC keyword) 210  
Load (Diary command) 172  
Load (PipeDream command) 44, 126  
loading a BASIC program 210  
loading in PipeDream 44  
LOCAL (BASIC keyword) 210  
LOCK OUT state 79  
LOG (BASIC keyword) 210  
LOG (PipeDream function) 156  
LOMEM (BASIC keyword) 210  
LOOKUP (PipeDream function) 156

**M**

Margin Left (PipeDream command) 132  
Margin Right (PipeDream command) 132  
margins in PipeDream 131, 142  
Mark Block (Diary command) 162  
Mark Block (PipeDream command) 50  
marking blocks in PipeDream 50, 104  
MAX (PipeDream function) 157  
Memory Free (Diary command) 171  
memory low 24  
MENU key 16  
menu, selecting 21  
Microspace pitch (PipeDream command) 147

microspacing in PrinterEd 191  
 MID\$ (BASIC keyword) 210  
 MIN (PipeDream function) 157  
 MOD (BASIC keyword) 211  
 MONTH (PipeDream function) 157  
 Move (Diary command) 162  
 Move (PipeDream command) 108  
 moving around a PipeDream  
   document 57  
 moving between days in the Diary 66  
 moving blocks in PipeDream 108  
 moving in PipeDream 114  
 moving within the Calendar 75  
 multi-column document, creating 132  
 multi-file documents in PipeDream  
   126, 128, 147  
 multi-file example 129

## N

\*NAME 222  
 Name (PipeDream command) 126  
 Name (PrinterEd command) 193  
 Name Match (Filer command) 179  
 name and address list example 46  
 NEW (BASIC keyword) 211  
 New (PipeDream command) 44, 113  
 New (PrinterEd command) 193  
 NEXT (BASIC keyword) 211  
 Next Active Day (Diary command) 168  
 Next Column (PipeDream command)  
   116  
 Next Day (Diary command) 168  
 Next File (PipeDream command) 129  
 Next Match (Diary command) 164  
 Next Match (PipeDream command)  
   53, 109  
 Next Option (Diary command) 171  
 Next Option (PipeDream command)  
   139  
 Next Word (Diary command) 167  
 Next Word (PipeDream command) 115  
 NM in Filer DIRECTORY window. 179  
 NOT (BASIC keyword) 211

Number < > Text (PipeDream  
   command) 124  
 number formats in PipeDream 63, 136

## O

OLD (BASIC keyword) 212  
 ON (BASIC keyword) 212  
 ON ERROR (BASIC keyword) 212  
 OPENIN (BASIC keyword) 212  
 OPENOUT (BASIC keyword) 213  
 OPENUP (BASIC keyword) 213  
 operations  
   executing 22  
   selecting 22  
 operators  
   in BASIC 223  
   in PipeDream 152  
   precedence of 225  
 OPT (BASIC keyword) 213  
 OPTIONS menu in PipeDream 138  
 Options Page (PipeDream command)  
   46  
 Options Page 138  
 Options Page in PipeDream 46  
 Options Page options  
   Auto/Man 141  
   Borders 140  
   Columns/Rows 141  
   Decimal places 141  
   File 138  
   Free 139  
   Insert on wrap 140  
   Insert/Overtyping 139  
   Justify 140  
   Lead chs. 141  
   Line spacing 142  
   Microspace 139  
   Minus/brackets 141  
   Page 139  
   Page length 142  
   Start page 142  
   Text/Numbers 140  
   Trail chs. 141  
   Wrap 140

options in commands 22, 103  
 OR (BASIC keyword) 214  
 OSCLI (BASIC keyword) 214  
 overprinting 189  
 Overtyping mode in PipeDream 38, 119  
 OZ information 18

## P

PAGE (BASIC keyword) 214  
 page breaks in PipeDream 122  
 page display map 33  
 Panel 14, 87  
 paragraphs in PipeDream 39  
 party invitation example 37  
 percentage calculations in the  
   Calculator 73  
 PI (BASIC keyword) 214  
 PI (PipeDream function) 157  
 PipeDream 11  
   error messages 233  
   file format 240  
   reference 103  
   screen 32  
   starting 32  
   using 31  
 popdowns 11  
   entering 19, 93  
   running 69  
   using 69  
 POS (BASIC keyword) 214  
 Previous Active Day (Diary command)  
   168  
 Previous Column (PipeDream  
   command) 116  
 Previous Day (Diary command) 168  
 Previous File (PipeDream command)  
   129  
 Previous Match (Diary command) 164  
 Previous Word (Diary command) 167  
 Previous Word (PipeDream command)  
   115  
 PRINT (BASIC keyword) 214  
 PRINT# (BASIC keyword) 215  
 PRINT menu in PipeDream 146

Print (PipeDream command) 44, 53, 146  
Printer Editor 187  
printer driver 187  
    editing 188  
PrinterEd 12, 187  
printing  
    expressions 124  
    from BASIC 198  
    in PipeDream 44  
    selected rows in PipeDream 54  
PROC (BASIC keyword) 215  
PTR# (BASIC keyword) 215  
◊PURGE 94  
PUT (BASIC keyword) 216

## R

RAD (BASIC keyword) 216  
RAD (PipeDream function) 157  
RAM cards 95  
ranges in expression slots 151  
READ (BASIC keyword) 216  
Recalculate (PipeDream command) 113  
redirecting input and output 181  
REM (BASIC keyword) 216  
Remove Highlights (PipeDream command) 149  
\*RENAME 222  
Rename (Filer command) 85  
RENUMBER (BASIC keyword) 216  
REPEAT (BASIC keyword) 216  
Replace (Diary command) 164  
Replace (PipeDream command) 109  
Replicate (PipeDream command) 59  
replicating slots 59  
REPORT (BASIC keyword) 217  
reset 24  
reset button 8  
RESTORE (BASIC keyword) 217  
Restore Position (Diary command) 166  
Restore Position (PipeDream command) 115  
RETURN (BASIC keyword) 217

Right Align (PipeDream command) 64, 134  
RIGHT\$ (BASIC keyword) 217  
RND (BASIC keyword) 217  
ROM cards 98  
ROW (PipeDream function) 157  
rows and columns in PipeDream 33  
RS232 connections 231  
RS232 parameters 89  
Rubout (Diary command) 170  
Rubout (PipeDream command) 119  
RUN (BASIC keyword) 217

## S

SAVE (BASIC keyword) 218  
Save (Diary command) 173  
Save (PipeDream command) 43, 127  
Save (PrinterEd command) 193  
Save Position (Diary command) 166  
Save Position (PipeDream command) 115  
Save to EPROM (Filer command) 84  
saving a BASIC program 218  
saving a document in PipeDream 43  
Screen Down (Diary command) 168  
Screen Down (PipeDream command) 116  
Screen Up (Diary command) 168  
Screen Up (PipeDream command) 116  
Search (Diary command) 67, 163  
Search (PipeDream command) 52, 109  
searching for a day in the Calendar 76  
searching for Diary entries 67  
Select Device (Filer command) 96, 177  
Select Directory (Filer command) 177  
Select Extra File (Filer command) 83  
Select First File (Filer command) 83  
selecting files 83  
serial port 231  
serial port parameters 89  
Set Margin (PipeDream command) 132  
setting an alarm 78  
SGN (BASIC keyword) 218

SGN (PipeDream function) 157  
short cuts 23  
Sign Brackets (PipeDream command) 136  
Sign Minus (PipeDream command) 136  
SIN (BASIC keyword) 218  
SIN (PipeDream function) 158  
slot references 58  
slots in PipeDream 33  
soft reset 24  
Sort (PipeDream command) 51, 108  
sorting in PipeDream 50, 108  
SPC (BASIC keyword) 218  
specification of Z88 243  
Split Line (Diary command) 171  
Split Line (PipeDream command) 120  
spooling files from the Terminal 186  
spreadsheet example 56  
SQR (BASIC keyword) 218  
SQR (PipeDream function) 158  
Start of Line (Diary command) 167  
STEP (BASIC keyword) 218  
STOP (BASIC keyword) 219  
STR\$ (BASIC keyword) 219  
STRING\$ (BASIC keyword) 219  
styles, adding to text 41  
Subscript (PipeDream command) 148  
SUM (PipeDream function) 158  
Superscript (PipeDream command) 148  
suspended activities 20, 93  
Swap Case (Diary command) 171  
Swap Case (PipeDream command) 120  
switching off 10  
switching on 8, 10  
system information 222

## T

T junction escape sequence 180  
TAB (BASIC keyword) 219  
TAB (Diary command) 166  
TAB key 16

TAN (BASIC keyword) 219  
TAN (PipeDream function) 158  
Terminal 12, 185  
text slots 35  
THEN (BASIC keyword) 219  
TIME (BASIC keyword) 220  
TIME\$ (BASIC keyword) 220  
title in PipeDream 144  
TO (BASIC keyword) 220  
Today (Diary command) 168  
TOP (BASIC keyword) 220  
Top File (PipeDream command) 129  
Top of Column (PipeDream command)  
57, 116  
TRACE (BASIC keyword) 220  
Trailing Characters (PipeDream  
command) 63, 136  
translating codes in PrinterEd 192  
Tree Copy (Filer command) 178  
TRUE (BASIC keyword) 221  
tutorial section 27  
typing text in PipeDream 37

## U

Underline (PipeDream command) 148  
units conversion in the Calculator 74  
UNTIL (BASIC keyword) 221  
Up Directory (Filer command) 178  
Update Driver (PrinterEd command)  
187, 193  
User Defined (PipeDream command)  
148  
USR (BASIC keyword) 221

## V

VAL (BASIC keyword) 221  
VDU (BASIC keyword) 221  
vectors in BASIC 224  
VPOS (BASIC keyword) 221

## W

WIDTH (BASIC keyword) 221  
Width (PipeDream command) 47, 54,  
131

wildcards  
in Filer 176  
in PipeDream 53, 110  
Word Count (PipeDream command)  
113  
word wrap in PipeDream 38  
word processing example 37

## Y

YEAR (PipeDream function) 158

## Z

Z80 assembler 213  
Z88 character set 237  
Z88 ROM release number 222  
Z88 specification 243

^# in PipeDream 53  
^# wild field 111  
^? in PipeDream 53  
^? wild field 111